

KAISAI

**WE
CARE
ABOUT
AIR**

R32



ENGINEERING DATA
MONO TYPE HEAT PUMP

CONTENTS

Part 1 General Information.....	3
Part 2 Engineering Data	19
Part 3 Installation and Field Settings.....	35

Part 1

General Information

1 Mono System	4
2 Unit Capacities	6
3 Nomenclature	6
4 System Design and Unit Selection	7
5 Typical Applications	9

Mono

1 Mono System

1.1 System Schematic

Figure 1-1.1: System schematic

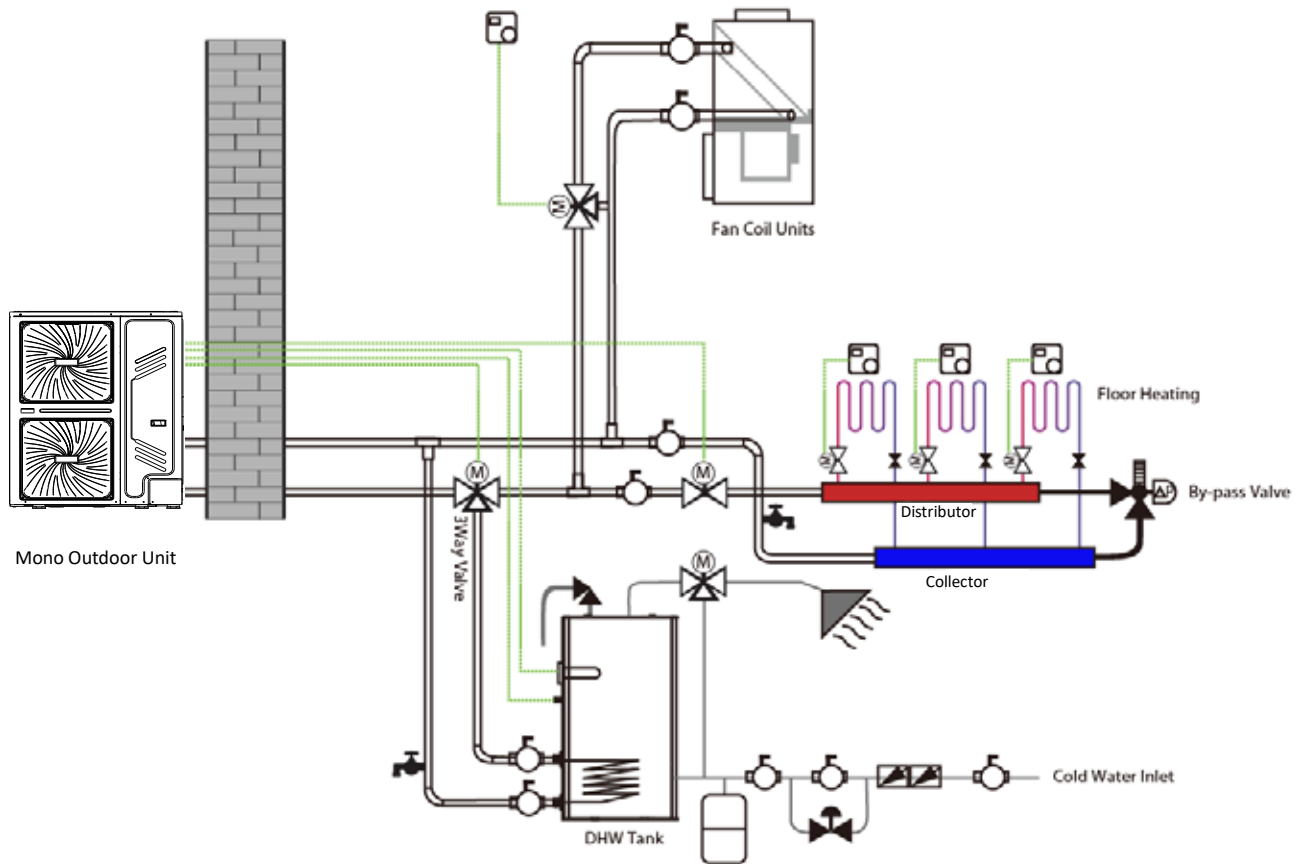

Mono is an integrated air to water heat pump system which is one-stop solution for space heating, space cooling and domestic hot water. The outdoor heat pump system extracts heat from the outdoor air and transfers this heat through refrigerant piping to the plate heat exchanger in the hydronic system. The heated water in the hydronic system circulates to low temperature heat emitters (floor heating loops or low temperature radiators) to provide space heating, and to the domestic hot water tank to provide domestic hot water. The 4-way valve in the outdoor unit can reverse the refrigerant cycle so that the hydronic system can provide chilled water for cooling using fan coil units.

The heating capacity of heat pumps decreases with ambient temperature dropping. Mono can be equipped with a backup electric heater to provide additional heating capacity for use during extremely cold weather when the heat pump capacity is insufficient. The backup electric heater also serves as a backup in case of heat pump malfunction and for anti-freeze protection of the outside water piping in winter.

1.2 System Configurations

Mono can be configured to run with the electric heater either enabled or disabled and can also be used in conjunction with an auxiliary heat source such as a boiler.

The chosen configuration affects the size of heat pump that is required. Three typical configurations are described below. Refer to Figure 1-1.2.

Configuration 1: Heat pump only

- The heat pump covers the required capacity and no extra heating capacity is necessary.
- Requires selection of larger capacity heat pump and implies higher initial investment.
- Ideal for new construction in projects where energy efficiency is paramount.

Configuration 2: Heat pump and backup electric heater

- Heat pump covers the required capacity until the ambient temperature drops below the point at which the heat pump is able to provide sufficient capacity. When the ambient temperature is below this equilibrium point (as shown in Figure 1-1.2), the backup electric heater supplies the required additional heating capacity.
- Best balance between initial investment and running costs, results in lowest lifecycle cost.
- Ideal for new construction.

Configuration 3: Heat pump with auxiliary heat source

- Heat pump covers the required capacity until the ambient temperature drops below the point at which the heat pump is able to provide sufficient capacity. When the ambient temperature is below this equilibrium point (as shown in Figure 1-1.2), depending on the system settings, either the auxiliary heat source supplies the required additional heating capacity or the heat pump does not run and the auxiliary heat source covers the required capacity.
- Enables selection of lower capacity heat pump.
- Ideal for refurbishments and upgrades.

Figure 1-1.2: System configurations

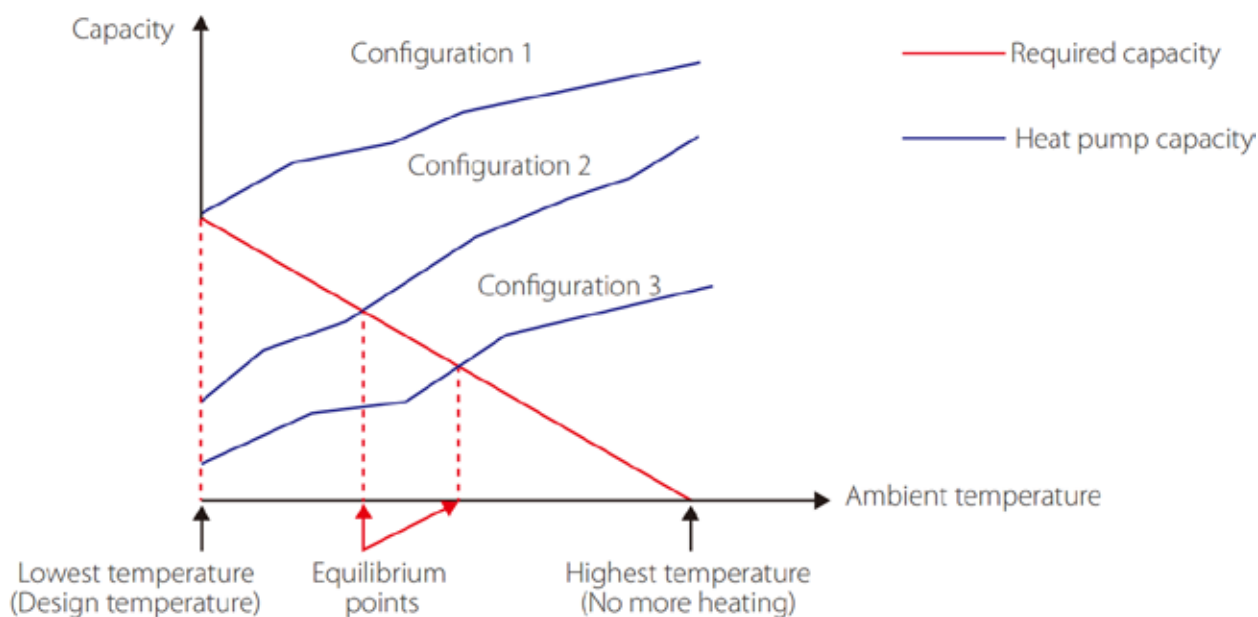

4 System Design and Unit Selection

4.1 Selection Procedure

Step 1: Total heat load calculation

Calculate conditioned surface area
Select the heat emitters (type, quantity, water temperature and heat load)

Step 2: System configuration

Decide whether to include AHS and set AHS's switching temperature
Decide whether backup electric heater is enabled or disabled

Step 3: Selection of outdoor units

Determine required total heat load on outdoor units
Set capacity safety factor
Select power supply

Provisionally select Mono unit capacity based on nominal capacity

Correct capacity of the outdoor units for the following items:
Outdoor air temperature / Outdoor humidity / Water outlet temperature¹ /
Altitude / Anti-freeze fluid

Is corrected Mono unit capacity \geq Required total heat load on outdoor units²

Yes

No

Mono system selection
is complete

Select a larger model or enable
backup electric heater operation

Notes:

1. If the required water temperatures of the heat emitters are not all the same, the Mono's outlet water temperature setting should be set at the highest of the heat emitter required water temperatures. If the water outlet design temperature falls between two temperatures listed in the outdoor unit's capacity table, calculate the corrected capacity by interpolation.
2. Select Mono units which should satisfy both total heating and cooling load requirements.

Mono

4.2 Leaving Water Temperature (LWT) Selection

The recommended design LWT ranges for different types of heat emitter are:

- For floor heating: 30 to 35°C
- For fan coil units: 30 to 45°C
- For low temperature radiators: 40 to 50°C

4.3 Optimizing System Design

To get the most comfort with the lowest energy consumption with Mono, it is important to take account of the following considerations:

- Choose heat emitters that allow the heat pump system to operate at as low a hot water temperature as possible whilst still providing sufficient heating.
- Make sure the correct weather dependency curve is selected to match the installation environment (building structure, climate) as well as ender user's demands.
- Connecting room thermostats (field supplied) to the hydronic system helps prevent excessive space heating by stopping the outdoor unit and circulator pump when the room temperature is above the thermostat set point.

4.4 Tank back up heater notice

Heat pump will stop when T5(tank temperature) has reached the minimum of both T5S(tank setting temperature) and T5stop (highest tank temperature which can be reached under certain ambient temperature with heat pump only) and lasted for 5s. The value of T5stop is shown as below.

If T5S is higher than T5stop, then T5S can not be reached with heat pump only. In this case, tank back up heater is needed in order to reach T5S.

T5stop value:

Ambient temperature(°C)	-25~21	-20~14	-15~-11	-10~-4	-5~-1	0~4	5~9
T5stop(°C)	35	40	45	48	50	53	55
Ambient temperature(°C)	10~14	15~19	20~24	25~29	30~34	35~39	40~43
T5stop(°C)	55	53	50	50	48	48	45

5 Typical Applications

5.1 Space Heating

The room thermostat is used as a switch. When there is a heating request from the room thermostat, the Mono unit operates to achieve the target water temperature set on the user interface. When the room temperature reaches the thermostat's set temperature, the unit stops.

Figure 1-5.1: Space heating

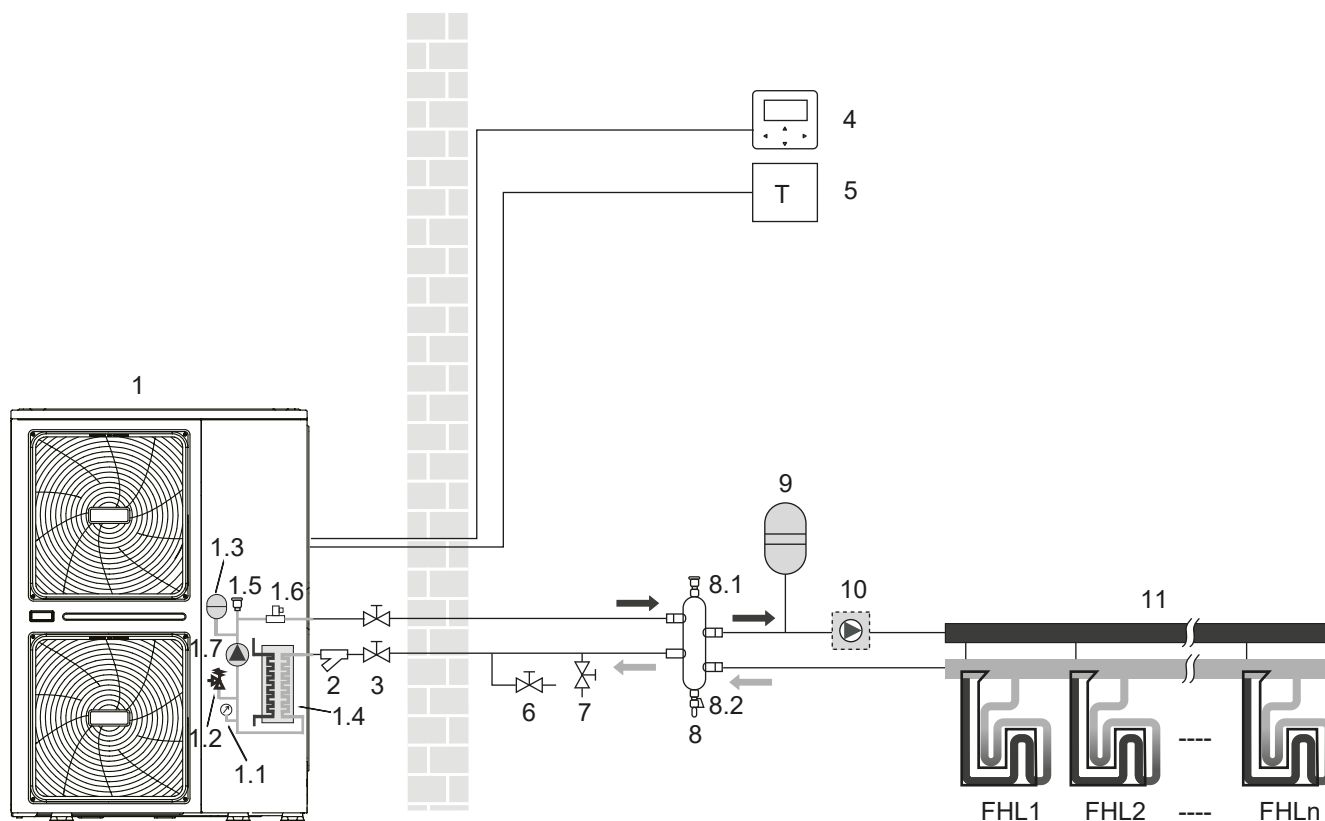

Table 1-5.1: Space heating

Legend			
1	Outdoor unit	5	Room thermostat (field supplied)
1.1	Manometer	6	Drain valve (field supplied)
1.2	Pressure relief valve	7	Fill valve (field supplied)
1.3	Expansion vessel	8	Balance tank (field supplied)
1.4	Plate heat exchanger	8.1	Air purge valve
1.5	Air purge valve	8.2	Drain valve
1.6	Flow switch	9	Expansion vessel (field supplied)
1.7	P_i: Circulation pump inside the unit	10	P_o: Outside circulation pump (field supplied)
2	Y-shape filter	11	Collector / Distributor (field supplied)
3	Stop valve (field supplied)	FHL 1...n	Floor heating loop (field supplied)
4	Wired controller		

Notes:

1. The example is just for application illustration; please confirm the exact installation method according to the installation manual.

Mono

5.2 Space Heating and DHW with solar system

Space heating without room thermostat connected to the unit. Domestic hot water tank is connected to the unit, and the tank is with solar heating system. Solar water pump is controlled by T_{solar} temperature sensor. Balance tank temperature sensor is used to control on/off of heat pump. Once the heat pump stops, internal pump stops to save energy and then balance tank provides hot water for space heating. In addition, balance tank temperature control can meet both space heating and domestic hot water needs at the same time.

Figure 1-5.2: Space heating and DHW with solar system

Space heating without room thermostat connected to the unit. Domestic hot water tank is connected to the unit, and the tank is with solar heating system.

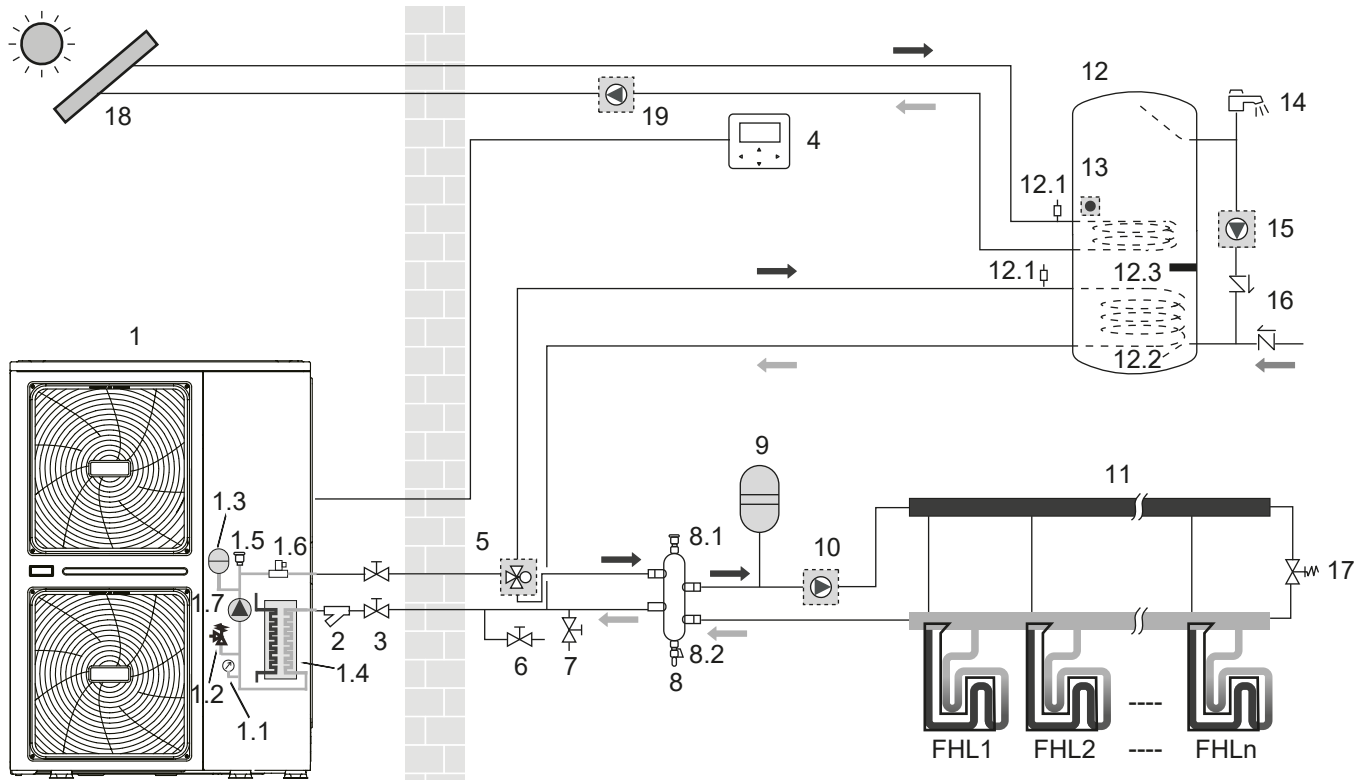

Table 1-5.2: Space heating and DHW with solar system

Legend			
1	Outdoor unit	8.2	Drain valve
1.1	Manometer	9	Expansion vessel (field supplied)
1.2	Pressure relief valve	10	P _o : Outside circulation pump (field supplied)
1.3	Expansion vessel	11	Collector / Distributor (field supplied)
1.4	Plate heat exchanger	12	Domestic hot water tank (field supplied)
1.5	Air purge valve	12.1	Air purge valve
1.6	Flow switch	12.2	Heat exchanger coil
1.7	P _i : Circulation pump inside the unit	12.3	Booster heater
2	Y-shape filter	13	T ₅ : Temperature sensor
3	Stop valve (field supplied)	14	Hot water tap(field supplied)
4	Wired controller	15	P _d : Cycle hot water pump (field supplied)
5	SV1: 3-way valve (field supplied)	16	One way valve(field supplied)
6	Drain valve (field supplied)	17	Bypass valve(field supplied)
7	Fill valve (field supplied)	18	Solar heater(field supplied)
8	Balance tank (field supplied)	19	P _s : Solar pump(field supplied)
8.1	Air purge valve	FHL 1...n	Floor heating loop (field supplied)

Notes:

1. The example is just for application illustration; please confirm the exact installation method according to the installation manual.

5.3 Space Heating, Cooling and DHW with solar system

Space cooling and heating application with a room thermostat suitable for heating/cooling changeover when connected to the unit. Heating is provided through floor heating loops and fan coil units. Cooling is provided through the fan coil units only. Domestic hot water is provided through the domestic hot water tank which is connected to the unit.

Figure 1-5.3: Space heating, cooling and DHW with solar system

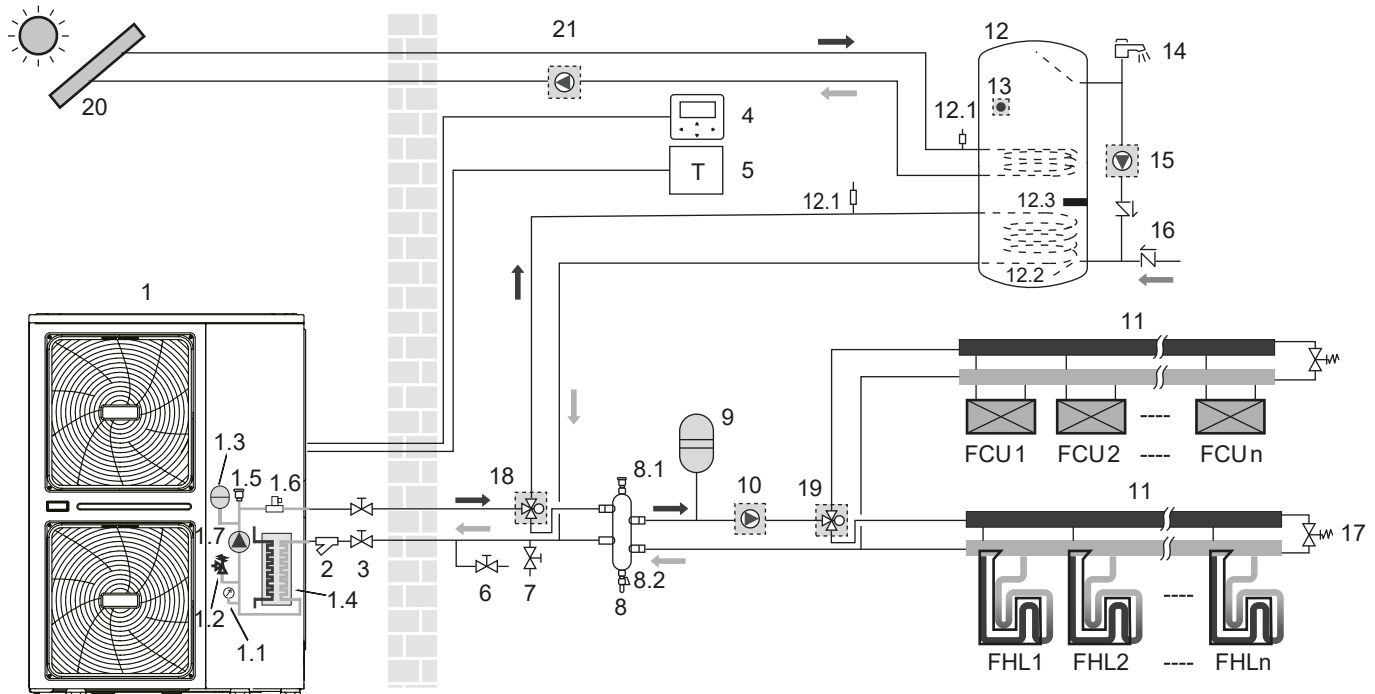

Table 1-5.3: Space heating, cooling and DHW with solar system

Legend			
1	Outdoor unit	10	P_o: Outside circulation pump (field supplied)
1.1	Manometer	11	Collector / Distributor (field supplied)
1.2	Pressure relief valve	12	Domestic hot water tank (field supplied)
1.3	Expansion vessel	12.1	Air purge valve
1.4	Plate heat exchanger	12.2	Heat exchanger coil
1.5	Air purge valve	12.3	Booster heater
1.6	Flow switch	13	T5: Temperature sensor
1.7	P_i: Circulation pump inside the unit	14	Hot water tap(field supplied)
2	Y-shape filter	15	P_d: Cycle hot water pump(field supplied)
3	Stop valve (field supplied)	16	One way valve(field supplied)
4	Wired controller	17	Bypass valve(field supplied)
5	Room thermostat (field supplied)	18	SV1: 3-way valve(field supplied)
6	Drain valve (field supplied)	19	SV2: 3-way valve (field supplied)
7	Fill valve (field supplied)	20	Solar heater(field supplied)
8	Balance tank (field supplied)	21	P_s: Solar pump(field supplied)
8.1	Air purge valve	FHL 1...n	Floor heating loop (field supplied)
8.2	Drain valve	FCU 1...n	Fan coil units(field supplied)
9	Expansion vessel (field supplied)		

Notes:

1. The example is just for application illustration; please confirm the exact installation method according to the installation manual.

Mono

5.4 AHS provides heat for space heating

Space heating application by either the unit or by AHS connected in the system.

If AHS only provides heat for space heating, AHS must be integrated in the piping work.

Figure 1-5.4: AHS provides heat for space heating

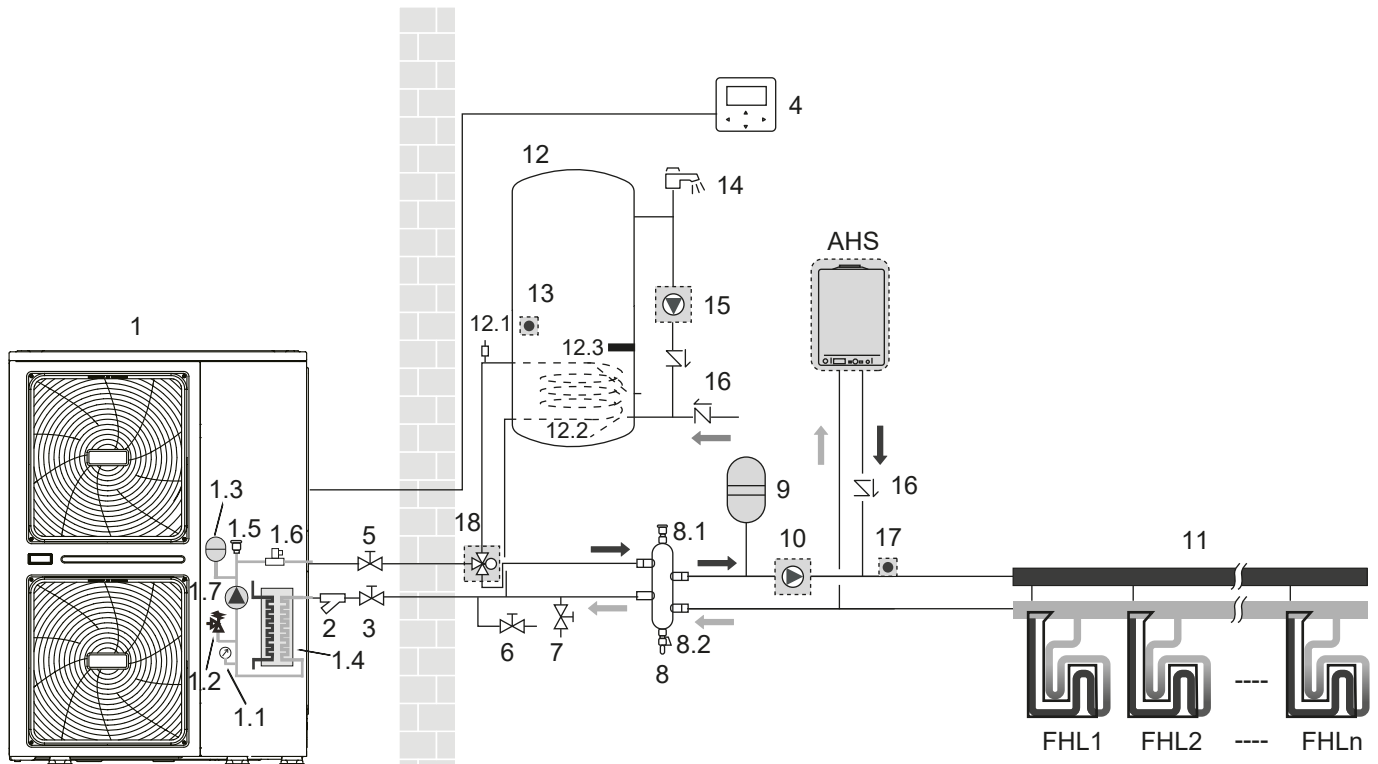

Table 1-5.4: AHS provides heat for space heating

Legend			
1	Outdoor unit	8.2	Drain valve
1.1	Manometer	9	Expansion vessel (field supplied)
1.2	Pressure relief valve	10	P_o: Outside circulation pump (field supplied)
1.3	Expansion vessel	11	Collector / Distributor (field supplied)
1.4	Plate heat exchanger	12	Domestic hot water tank (field supplied)
1.5	Air purge valve	12.1	Air purge valve
1.6	Flow switch	12.2	Heat exchanger coil
1.7	P_i: Circulation pump inside the unit	12.3	Booster heater
2	Y-shape filter	13	T5: Temperature sensor
3	Stop valve (field supplied)	14	Hot water tap(field supplied)
4	Wired controller	15	P_d: Cycle hot water pump(field supplied)
5	Stop valve (field supplied)	16	One way valve(field supplied)
6	Drain valve (field supplied)	17	T1: Outlet water temperature sensor(field supplied)
7	Fill valve (field supplied)	18	SV1: 3-way valve (field supplied)
8	Balance tank (field supplied)	FHL 1...n	Floor heating loop (field supplied)
8.1	Air purge valve		

Notes:

1. The example is just for application illustration; please confirm the exact installation method according to the installation manual.

5.5 AHS provides heat for space heating and DHW

Space heating application by either the unit or by AHS connected in the system. Bivalent operation is possible for both space heating operation and domestic water heating operation. If AHS is also providing heat for domestic hot water, AHS can be integrated in the piping work. In this condition, the unit can send ON/OFF signal to AHS in heating mode, but AHS control itself in DHW mode.

Figure 1-5.5: AHS provides heat for space heating and DHW

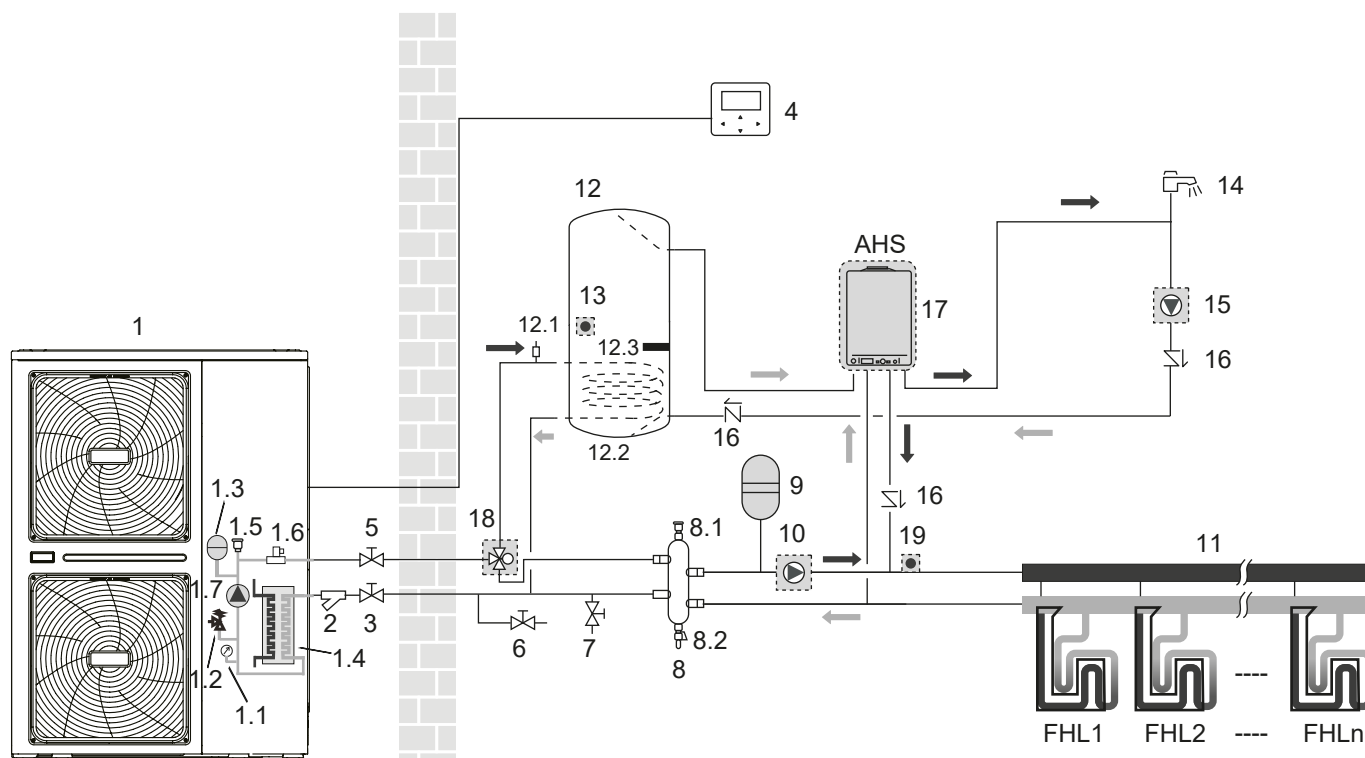

Table 1-5.5: AHS provides heat for space heating and DHW

Legend			
1	Outdoor unit	8.2	Drain valve
1.1	Manometer	9	Expansion vessel (field supplied)
1.2	Pressure relief valve	10	P_o: Outside circulation pump (field supplied)
1.3	Expansion vessel	11	Collector / Distributor (field supplied)
1.4	Plate heat exchanger	12	Domestic hot water tank (field supplied)
1.5	Air purge valve	12.1	Air purge valve
1.6	Flow switch	12.2	Heat exchanger coil
1.7	P_i: Circulation pump inside the unit	12.3	Booster heater
2	Y-shape filter	13	T5: Temperature sensor
3	Stop valve (field supplied)	14	Hot water tap(field supplied)
4	Wired controller	15	P_d: Cycle hot water pump(field supplied)
5	Stop valve (field supplied)	16	One way valve(field supplied)
6	Drain valve (field supplied)	17	Additional heat source(field supplied)
7	Fill valve (field supplied)	18	SV1: 3-way valve (field supplied)
8	Balance tank (field supplied)	19	T1: Outlet water temperature sensor(field supplied)
8.1	Air purge valve	FHL 1...n	Floor heating loop (field supplied)

Notes:

- The example is just for application illustration; please confirm the exact installation method according to the installation manual.

Mono

5.6 AHS provides heat for DHW

Figure 1-5.6: AHS provides heat for DHW

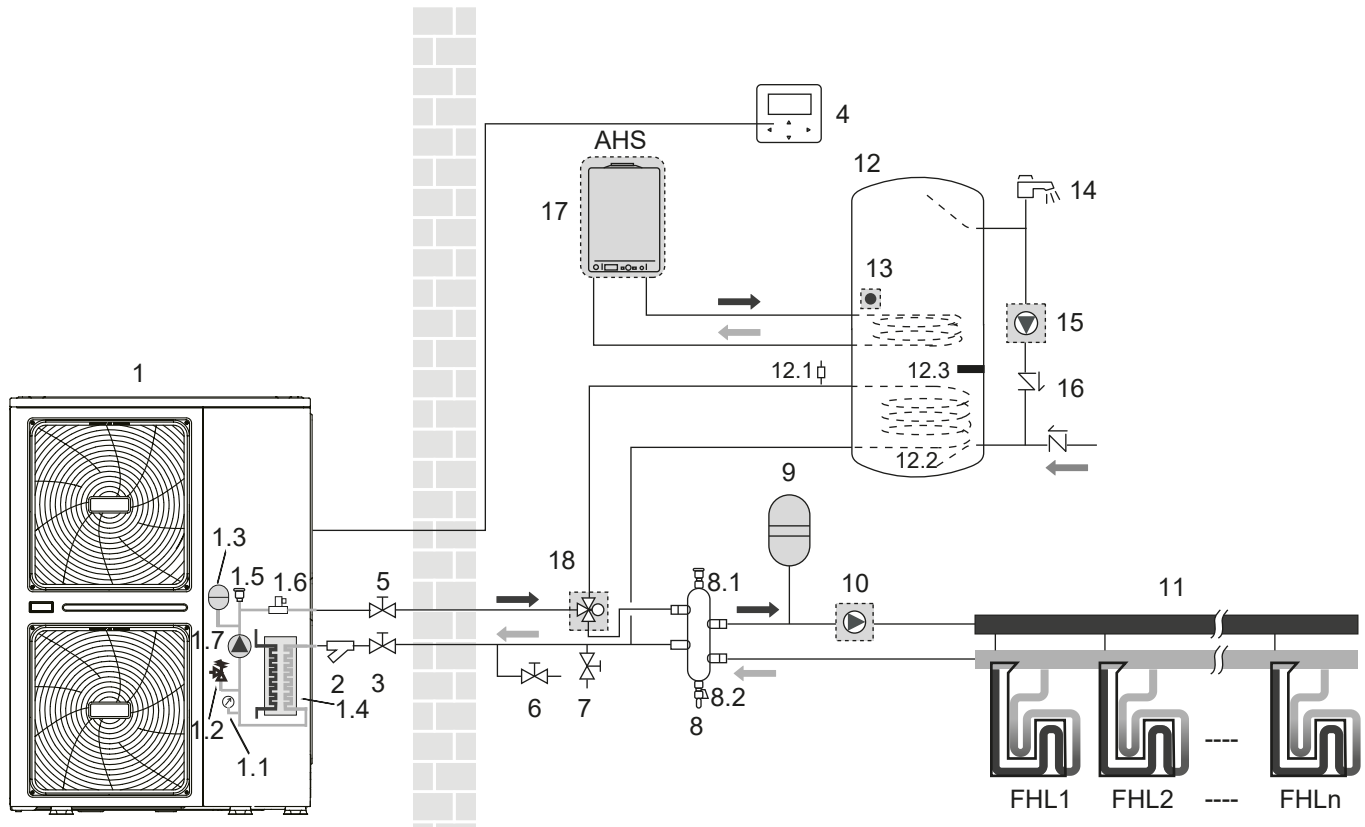

Table 1-5.6: AHS provides heat for DHW

Legend			
1	Outdoor unit	8.2	Drain valve
1.1	Manometer	9	Expansion vessel (field supplied)
1.2	Pressure relief valve	10	P_o: Outside circulation pump (field supplied)
1.3	Expansion vessel	11	Collector / Distributor (field supplied)
1.4	Plate heat exchanger	12	Domestic hot water tank (field supplied)
1.5	Air purge valve	12.1	Air purge valve
1.6	Flow switch	12.2	Heat exchanger coil
1.7	P_i: Circulation pump inside the unit	12.3	Booster heater
2	Y-shape filter	13	T5: Temperature sensor
3	Stop valve (field supplied)	14	Hot water tap(field supplied)
4	Wired controller	15	P_d: Cycle hot water pump(field supplied)
5	Stop valve (field supplied)	16	One way valve(field supplied)
6	Drain valve (field supplied)	17	Additional heat source(field supplied)
7	Fill valve (field supplied)	18	SV1: 3-way valve (field supplied)
8	Balance tank (field supplied)	FHL 1...n	Floor heating loop (field supplied)
8.1	Air purge valve		

Notes:

1. The example is just for application illustration; please confirm the exact installation method according to the installation manual.

5.7 Dual setpoint function application with two room thermostats

Space heating with two room thermostats application is through floor heating loops and fan coil units. The floor heating loops and fan coil units require different operating water temperature. The floor heating loops require a lower water temperature in heating mode compared to fan coil units. To achieve these two set points, a mixing station is used to adapt the water temperature according to requirements of the floor heating loops. The fan coil units are directly connected to the unit water circuit and the floor heating loops are after the mixing station. The mixing station is controlled by the unit (or field supply, controls by itself). With the help of hydronic adapter board(optional) which is connected between hydronic box and thermostats, maximum 8 thermostats for 8 rooms are available to control heat pump, which greatly improves the operation convenience.

Figure 1-5.7: Dual setpoint function application with two room thermostats

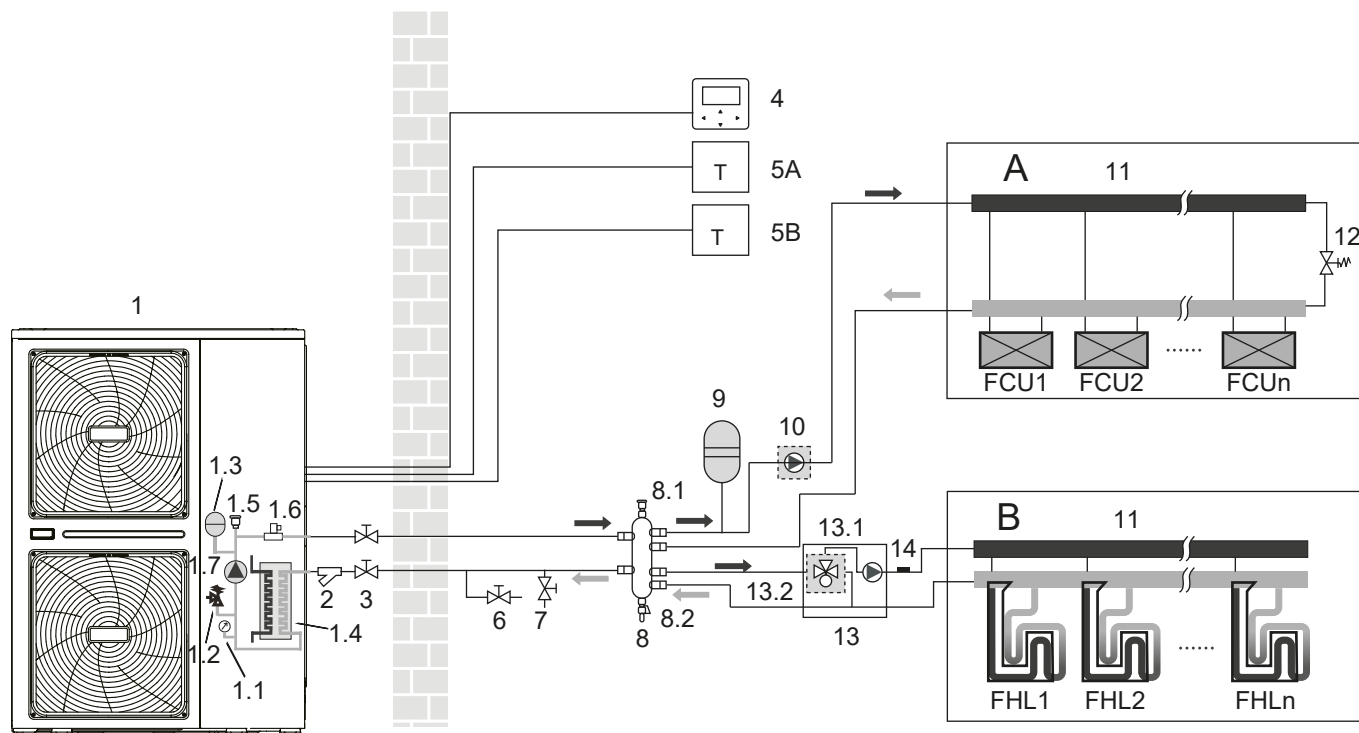

Table 1-5.7: Dual setpoint function application with two room thermostats

Legend			
1	Outdoor unit	7	Fill valve (field supplied)
1.1	Manometer	8	Balance tank (field supplied)
1.2	Pressure relief valve	8.1	Air purge valve
1.3	Expansion vessel	8.2	Drain valve
1.4	Plate heat exchanger	9	Expansion vessel (field supplied)
1.5	Air purge valve	10	P_o: Outside circulation pump (field supplied)
1.6	Flow switch	11	Collector / Distributor (field supplied)
1.7	P_i: Circulation pump inside the unit	12	Bypass valve (field supplied)
2	Y-shape filter	13	Mixing station(field supplied)
3	Stop valve (field supplied)	13.1	P_c: zone 2 pump (field supplied)
4	Wired controller	13.2	SV3: 3-way valve (field supplied)
5A	Room thermostat for zone 1 (field supply)	14	Tw2: Zone 2 water flow temp.(field supplied)
5B	Room thermostat for zone 2 (field supply)	FHL 1...n	Floor heating loop (field supplied)
6	Drain valve(field supplied)	FCU 1...n	Fan coil units (field supplied)

Notes:

1. The example is just for application illustration; please confirm the exact installation method according to the installation manual.

Mono

5.8 Dual setpoint function application without thermostats

Heating is provided through floor heating loops and fan coil units. The floor heating loops and fan coil units require different operating water temperatures. The floor heating loops require a lower water temperature in heating mode compared to fan coil units. To achieve these two set points, a mixing station is used to adapt the water temperature according to requirements of the floor heating loops. The fan coil units are directly connected to the unit water circuit and the floor heating loops are after the mixing station. The mixing station is controlled by the unit (or field supply, controls by itself).

Figure 1-5.8: Dual setpoint function application without thermostats

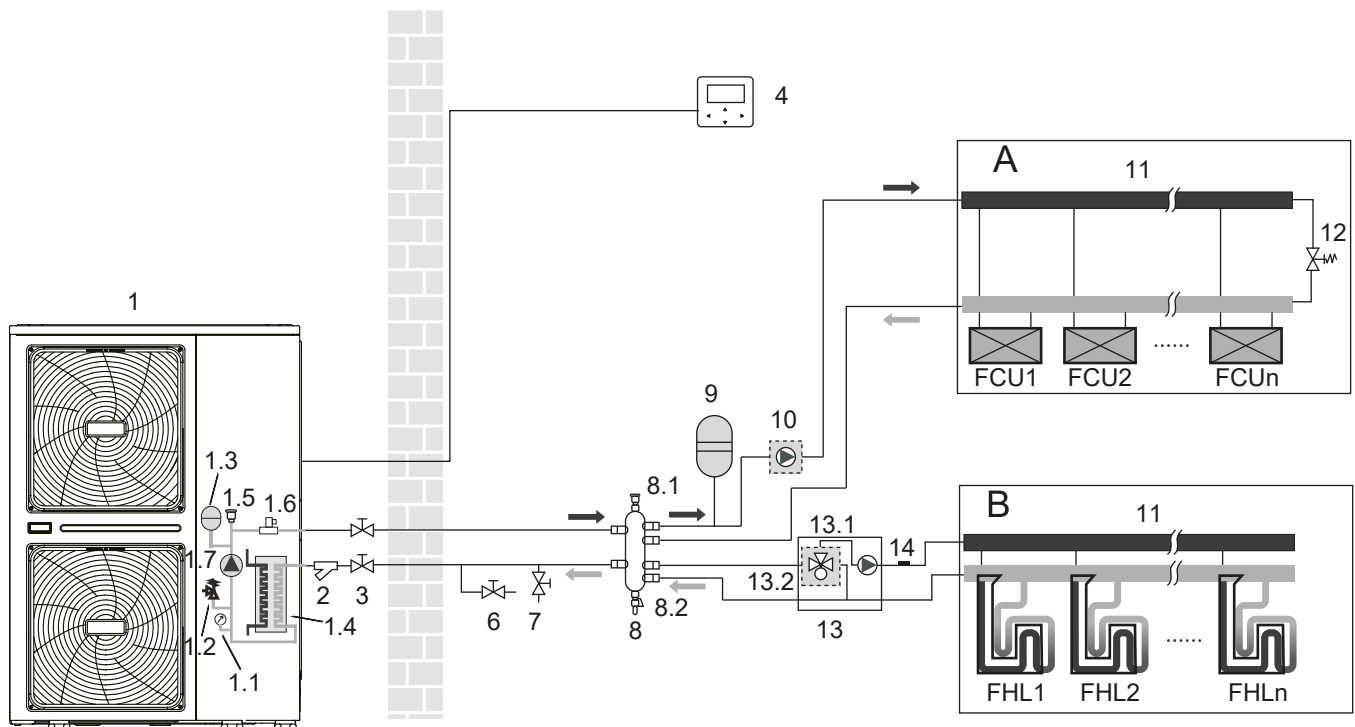

Table 1-5.8: Dual setpoint function application without thermostats

Legend			
1	Outdoor unit	8	Balance tank (field supplied)
1.1	Manometer	8.1	Air purge valve
1.2	Pressure relief valve	8.2	Drain valve
1.3	Expansion vessel	9	Expansion vessel (field supplied)
1.4	Plate heat exchanger	10	P_o: Outside circulation pump (field supplied)
1.5	Air purge valve	11	Collector / Distributor (field supplied)
1.6	Flow switch	12	Bypass valve (field supplied)
1.7	P_i: Circulation pump inside the unit	13	Mixing station(field supplied)
2	Y-shape filter	13.1	P_c: zone 2 pump (field supplied)
3	Stop valve (field supplied)	13.2	SV3: 3-way valve (field supplied)
4	Wired controller	14	Tw2: Zone 2 water flow temp.(field supplied)
5	Stop valve (field supplied)	FHL 1...n	Floor heating loop (field supplied)
6	Drain valve(field supplied)	FCU 1...n	Fan coil units (field supplied)
7	Fill valve (field supplied)		

Notes:

1. The example is just for application illustration; please confirm the exact installation method according to the installation manual.

5.9 Group control function for cooling, heating and DHW

Modularity is perfect when an extension of capacity becomes required as the building cooling/heating demand evolves. 6 units can be controlled in group. The group control system can control and view the operation of the entire system only by connecting the master to the wire controller. If the DHW function is required, the water tank can only be connected to the master unit water circuit through a three-way valve, and controlled by the master unit. If AHS is needed, it can only be connected to the master waterway and controlled by the master unit. The Tbt1 temperature sensor must be installed in the parallel system (otherwise unit cannot be started). If the balance tank is too large, Tbt2 needs to be added in order to improve the control accuracy. Tbt2 is set in the lower part of the balance tank. The water inlet and outlet pipe joints of each unit of the parallel system should be connected with soft connections and one-way valves must be installed at the water outlet pipe

Figure 1-5.9: Group control function for cooling, heating and DHW

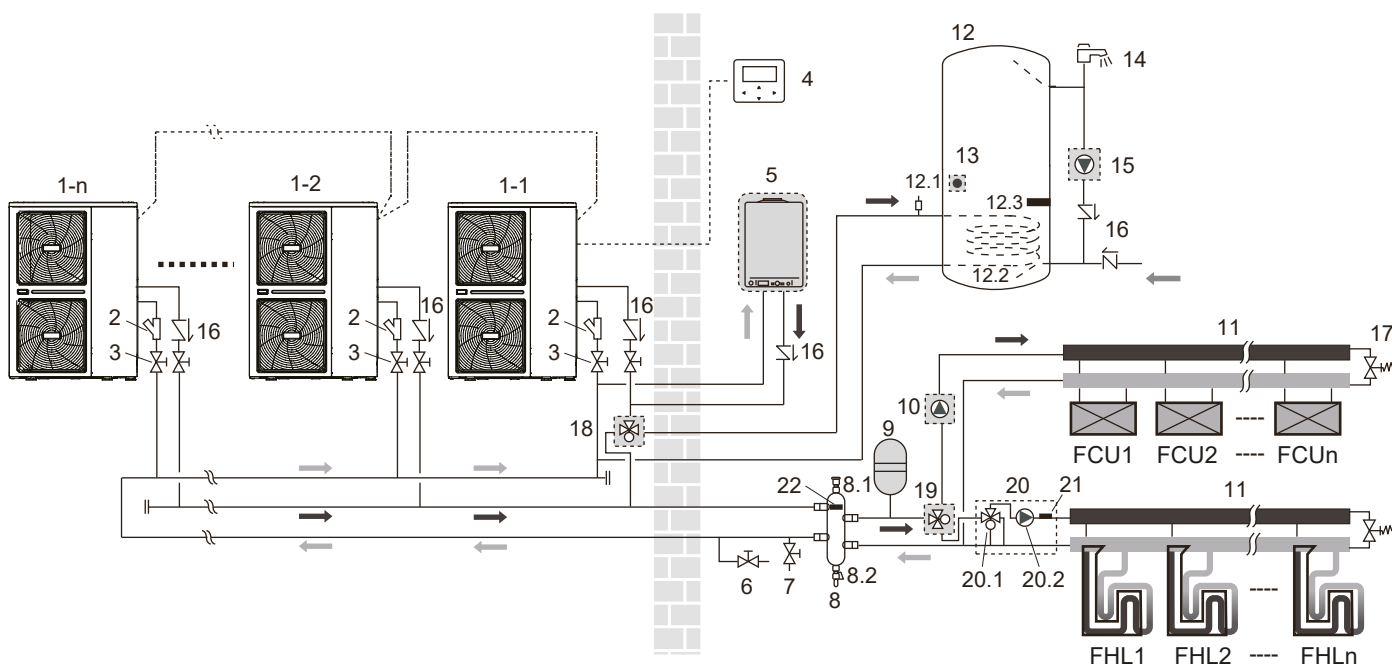

Table 1-5.9: Group control function for cooling, heating and DHW

Legend			
1-1	Outdoor unit: master	12.2	Heat exchanger coil
1-2...1-n	Outdoor unit: slave	12.3	Booster heater
2	Y-shape filter	13	T5: DHW tank temp. sensor
3	Stop valve (field supply)	14	Hot water tap (field supply)
4	Wired controller	15	P_d: DHW pump (field supply)
5	Additional heating source(boiler) (field supply)	16	One way valve (field supply)
6	Drain valve (field supply)	17	Bypass valve(field supply)
7	Fill valve (field supply)	18	SV1: 3-way valve (field supply)
8	Balance tank (field supply)	19	SV1: 3-way valve (field supply)
8.1	Air purge valve	20	Mixing station (field supply)
8.2	Drain valve	20.1	P_c: zone 2 pump (field supply)
9	Expansion vessel (field supply)	20.2	SV3: 3-way valve (field supply)
10	P_o: Outside circulation pump (field supply)	21	Tw2: Zone 2 water flow temp. (individual purchase)
11	Collector / distributor (field supply)	22	Tbt1: Balance tank temp. sensor (individual purchase)
12	Domestic hot water tank (field supply)	FHL 1...n	Floor heating loop (field supply)
12.1	Air purge valve	FCU 1...n	Fan coil units (field supply)

Notes:

1. The example is just for application illustration; please confirm the exact installation method according to the installation manual.

Part 2

Engineering Data

1 Specifications	20
2 Electrical characteristics	21
3 Dimensions and Center of Gravity	21
4 Capacity Tables.....	22
5 Operating Limits.....	28
6 Hydronic Performance.....	29
7 Sound Levels	30
8 Accessories	33

1 Specifications

Model name			KHC-22RX3	KHC-30RX3
Power supply		V/Ph/Hz	380-415/3/50	
Heating(A7W35)	Capacity	W	22000	30100
	Rated input	W	5000	7698
	COP		4.40	3.91
Heating(A7W45)	Capacity	W	22000	30000
	Rated input	W	6471	10345
	COP		3.40	2.90
Heating(A7W55)	Capacity	W	22000	30000
	Rated input	W	8302	13043
	COP		2.65	2.30
Heating(A-7W35)	Capacity	W	21000	23000
	Rated input	W	8077	9388
	COP		2.60	2.45
Cooling(A35W18)	Capacity	W	23000	31000
	Rated input	W	5000	7750
	EER		4.60	4.00
Cooling(A35W7)	Capacity	W	21000	29500
	Rated input	W	7119	11569
	EER		2.95	2.55
Seasonal space heating energy efficiency class	Water outlet at 35°C / 55°C	class	A+++ / A++	A++ / A+
SCOP	Warmer climate	35°C	5.93	5.40
		55°C	4.10	4.15
	Average climate	35°C	4.53	4.20
		55°C	3.23	3.15
	Colder climate	35°C	3.73	3.53
		55°C	2.63	2.58
SEER	Water outlet at 7°C / 18°C		4.70 / 5.67	4.49 / 5.71
Compressor		Type	Twin rotary DC inverter	
Outdoor fan motor		Type	Brushless DC motor	
Water side heat exchanger			Plate type	
Water pump	Max. pump head	m	12	12
Refrigerant (R32)	Charged volume	kg	5.0	
Throttle type			Electronic expansion valve	
Sound power level ²		dB	73	77
Rated water flow		m ³ /h	3.78	5.18
Internal water volume		L	3.5	3.5
Unit dimension / Packing dimension (W×H×D)		mm	1129×1558×528 / 1220×1735×565	
Net / Gross weight		kg	177 / 206	
Water piping connections Dia.		inch	1-1/4" BSP	1-1/4" BSP
Ambient temperature range	Cooling	°C	-5-46	
	Heating	°C	-25-35	
	DHW	°C	-25-43	

Water setting temperature range	Cooling	°C	5-25
	Heating	°C	25-60
	DHW ³	°C	30-60

Notes:

1. Relevant EU standards and legislation: EN14511; EN14825; EN50564; EN12102; (EU) No 811/2013; (EU) No 813/2013; OJ 2014/C 207/02.
2. Test standard: EN12102-1
3. Maximum domestic hot water temperature 60°C is only available with TBH support.

2 Electrical characteristics

System	Outdoor unit				Power current			Compressor		Fan	
	Voltage (V)	Hz	Min. (V)	Max. (V)	MCA (A)	TOCA (A)	MFA (A)	MSC (A)	RLA (A)	kW	FLA (A)
KHC-22RX3	380~415	50	342	456	24.5	28	25	-	14	0.34	3
KHC-30RX3	380~415	50	342	456	28.5	28	32	-	21	0.34	3

Note:

MCA: Min. Circuit Amps. (A)

TOCA: Total Over-current Amps. (A)

MFA: Max. Fuse Amps. (A)

MSC: Max. Starting Amps. (A)

RLA: Rated Load Amps. (A)

The input Amps of compressor where MAX. Hz can operate for nominal cooling or heating test condition

kW: Rated Motor Output

FLA: Full Load Amps. (A)

3 Dimensions and Center of Gravity

Figure 2-2.1: KHC-22RX3, KHC-30RX3 dimensions and center of gravity (unit: mm)

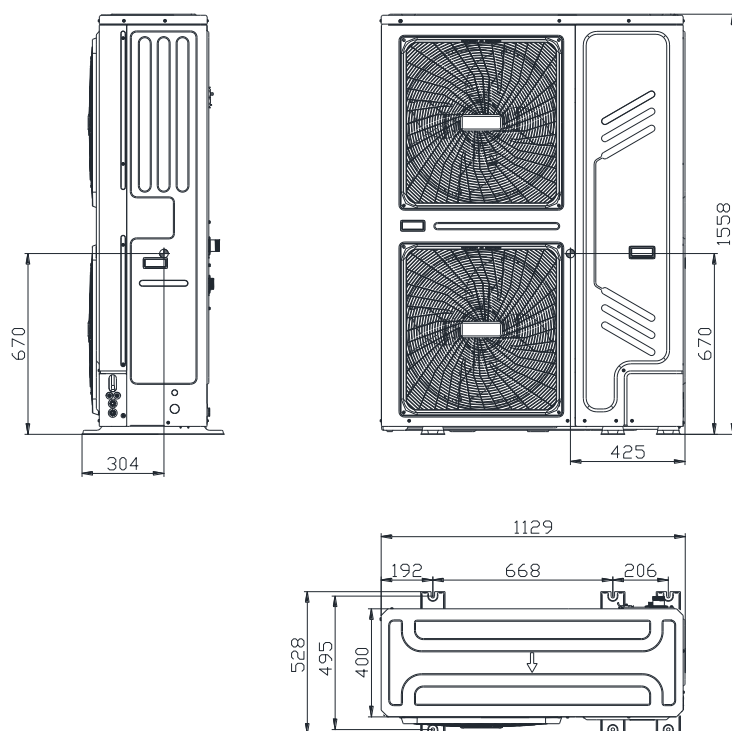

4 Capacity Tables

4.1 Heating Capacity Tables (Test standard: EN14511)

Table 2-4.1: KHC-22RX3 heating capacity - peak values¹

Outdoor air temp.	LWT (°C)																				
	30			35			40			45			50			55			60		
°C DB	HC	PI	COP	HC	PI	COP	HC	PI	COP	HC	PI	COP	HC	PI	COP	HC	PI	COP	HC	PI	COP
-25.0	10174	6756	1.51	9123	7154	1.28															
-20.0	12899	6067	2.13	11566	6424	1.80	10234	6782	1.51												
-15.0	20342	7021	2.90	19112	8206	2.33	17973	9705	1.85	16782	11251	1.49	14704	11423	1.29						
-10	22770	7972	2.86	22000	8861	2.48	21609	9866	2.19	21191	10901	1.94	18987	10952	1.73	12202	10922	1.12	8529	7893	1.08
-7.0	24093	8271	2.91	23733	9254	2.56	23791	9963	2.39	23836	10691	2.23	21846	10470	2.09	13558	10441	1.30	9946	8124	1.22
-5.0	25944	8376	3.10	25423	9289	2.74	25347	10043	2.52	25252	10817	2.33	23008	10627	2.16	15564	10743	1.45	12091	9304	1.30
-2.0	28722	8702	3.30	27958	9343	2.99	27680	10163	2.72	27375	11005	2.49	23397	10626	2.20	18573	11196	1.66	14958	11305	1.32
0	28274	8037	3.52	27530	8709	3.16	26787	9382	2.86	26043	10054	2.59	24722	10978	2.25	21601	10987	1.97	19108	11100	1.72
2	29878	7993	3.74	29100	8743	3.33	28321	9492	2.98	27542	10242	2.69	27112	10959	2.47	24629	10778	2.29	22717	11224	2.02
5	24792	6189	4.01	23920	6684	3.58	23049	7178	3.21	22177	7673	2.89	21966	8497	2.59	21754	9321	2.33	21543	10344	2.08
7.0	25997	6215	4.18	24925	6468	3.85	23891	7096	3.37	22657	7511	3.02	22706	8542	2.66	22775	9089	2.51	22443	10552	2.13
10	25467	5928	4.30	24549	6290	3.90	23631	6652	3.55	22713	7015	3.24	22316	7676	2.91	21919	8337	2.63	21521	8999	2.39
15.0	28916	6484	4.46	28048	6789	4.13	27180	7095	3.83	26312	7401	3.56	25450	7657	3.32	24588	7913	3.11	23726	8169	2.90
20.0	28642	6171	4.64	27752	6407	4.33	26862	6644	4.04	25972	6881	3.77	24963	7064	3.53	23953	7248	3.30	22944	7431	3.09
25.0	28913	6010	4.81	27988	6192	4.52	27063	6373	4.25	26138	6555	3.99	24984	6679	3.74	23830	6803	3.50	22676	6928	3.27
30.0	30920	6224	4.97	29906	6364	4.70	28892	6505	4.44	27878	6645	4.20	26518	6722	3.95	25158	6798	3.70	23799	6875	3.46
35.0	12748	1735	7.35	12458	1923	6.48	12167	2110	5.77	11877	2298	5.17	11536	2619	4.41	11196	2940	3.81			

Abbreviations:

LWT: Leaving water temperature (°C)

HC: Total heating capacity (W)

PI: Power input (W)

Notes:

1. Integrated heating capacity values take account of capacity drops caused by frost accumulation and during defrosting.

Table 2-4.2: KHC-22RX3 heating capacity - integrated values¹

Outdoor air temp.	LWT (°C)																				
	30			35			40			45			50			55			60		
°C DB	HC	PI	COP	HC	PI	COP	HC	PI	COP	HC	PI	COP	HC	PI	COP	HC	PI	COP	HC	PI	COP
-25.0	8726	6366	1.37	8064	6892	1.17															
-20.0	11062	5716	1.94	10223	6188	1.65	9383	6660	1.41												
-15.0	16554	6653	2.49	15913	7348	2.17	14860	9099	1.63	13761	10907	1.26	12571	11272	1.12						
-10	20427	8048	2.54	19266	8196	2.35	18429	9176	2.01	17550	10186	1.72	15221	10274	1.48	10648	10010	1.06	7442	7234	1.03
-7.0	22348	8404	2.66	21279	8704	2.44	20570	9223	2.23	19824	9754	2.03	17426	9425	1.85	12547	10034	1.25	9204	7904	1.16
-5.0	23094	8219	2.81	22113	8611	2.57	21508	9221	2.33	20869	9847	2.12	18483	9601	1.93	13813	10050	1.37	10731	8985	1.19
-2.0	24215	8052	3.01	23364	8471	2.76	22915	9219	2.49	22435	9988	2.25	18925	9595	1.97	15713	10074	1.56	13392	10067	1.33
0	22920	7140	3.21	22469	7779	2.89	22018	8417	2.62	21568	9056	2.38	20738	9947	2.08	18377	10003	1.84	16511	10149	1.63
2	23355	6959	3.36	23244	7692	3.02	23132	8425	2.75	23021	9157	2.51	22908	9959	2.30	21042	9933	2.12	19629	10005	1.96
5	23541	6021	3.91	22623	6460	3.50	21704	6900	3.15	20786	7340	2.83	20672	8189	2.52	20559	9039	2.27	20445	9889	2.07
7.0	25997	6215	4.18	24925	6468	3.85	23891	7096	3.37	22657	7511	3.02	22706	8542	2.66	22775	9089	2.51	22443	10552	2.13
10	25467	5928	4.30	24549	6290	3.90	23631	6652	3.55	22713	7015	3.24	22316	7676	2.91	21919	8337	2.63	21521	8999	2.39
15.0	28916	6484	4.46	28048	6789	4.13	27180	7095	3.83	26312	7401	3.56	25450	7657	3.32	24588	7913	3.11	23726	8169	2.90
20.0	28642	6171	4.64	27752	6407	4.33	26862	6644	4.04	25972	6881	3.77	24963	7064	3.53	23953	7248	3.30	22944	7431	3.09
25.0	28913	6010	4.81	27988	6192	4.52	27063	6373	4.25	26138	6555	3.99	24984	6679	3.74	23830	6803	3.50	22676	6928	3.27
30.0	30920	6224	4.97	29906	6364	4.70	28892	6505	4.44	27878	6645	4.20	26518	6722	3.95	25158	6798	3.70	23799	6875	3.46
35.0	12748	1735	7.35	12458	1923	6.48	12167	2110	5.77	11877	2298	5.17	11536	2619	4.41	11196	2940	3.81			

Abbreviations:

LWT: Leaving water temperature (°C)

HC: Total heating capacity (W)

PI: Power input (W)

Notes:

1. Integrated heating capacity values take account of capacity drops caused by frost accumulation and during defrosting.

Table 2-4.3: KHC-30RX3 heating capacity - peak values¹

Outdoor air temp. °C DB	LWT (°C)																					
	30			35			40			45			50			55			60			
	HC	PI	COP	HC	PI	COP	HC	PI	COP	HC	PI	COP	HC	PI	COP	HC	PI	COP	HC	PI	COP	
-25.0	10495	7989	1.31	9553	8439	1.13																
-20.0	13266	6606	2.01	12076	6976	1.73	10887	7347	1.48													
-15.0	21600	6060	3.56	19955	8898	2.24	18873	11790	1.60	17740	14777	1.20	17283	16036	1.08							
-10	23336	7831	2.98	23038	9542	2.41	23147	11270	2.05	23245	13053	1.78	22937	14639	1.57	14692	13080	1.12	11046	9807	1.13	
-7.0	24516	9090	2.70	24888	9928	2.51	25711	10959	2.35	26547	12019	2.21	26933	12887	2.09	22278	14100	1.58	16470	12795	1.29	
-5.0	27005	9411	2.87	26704	10109	2.64	26874	11001	2.44	27033	11917	2.27	26721	12641	2.11	23263	14564	1.60	19236	12538	1.53	
-2.0	30739	9892	3.11	29428	10381	2.83	28618	11064	2.59	27762	11765	2.36	27612	12944	2.13	27907	14716	1.90	27664	17438	1.59	
0	32612	9711	3.36	31244	10562	2.96	30409	11617	2.62	29526	12703	2.32	29993	13980	2.15	29409	14730	2.00	28335	14653	1.93	
2	33318	8907	3.74	31942	9481	3.37	31111	11374	2.74	30700	12748	2.41	30582	13511	2.26	29866	13781	2.17	28047	13980	2.01	
5	31830	8363	3.81	31020	9257	3.35	30791	10348	2.98	30532	11310	2.70	30387	12427	2.45	29919	13651	2.19	28984	14005	2.07	
7.0	31177	8100	3.85	31754	9509	3.34	30825	9810	3.14	30992	11268	2.75	31077	12097	2.57	30563	13819	2.21	27332	12943	2.11	
10	30030	7459	4.03	30099	8373	3.59	30837	9493	3.25	31579	10654	2.96	30903	11281	2.74	30172	11925	2.53	27033	11579	2.33	
15.0	31835	7396	4.30	32695	8637	3.79	34334	10108	3.40	36014	11636	3.09	34020	11332	3.00	32585	11237	2.90	27197	9762	2.79	
20.0	32636	7055	4.63	32977	8075	4.08	34150	9322	3.66	35340	10620	3.33	33608	10510	3.20	32477	10618	3.06	27137	9328	2.91	
25.0	33876	6869	4.93	33763	7710	4.38	34535	8776	3.94	35302	9885	3.57	33766	9942	3.40	32877	10226	3.22	27519	9093	3.03	
30.0	36747	7036	5.22	36198	7749	4.67	36587	8684	4.21	36947	9657	3.83	35488	9862	3.60	34721	10306	3.37	29225	9313	3.14	
35.0	12696	1782	7.12	12405	1972	6.29	12113	2161	5.61	11821	2351	5.03	11577	2665	4.34	11333	2979	3.80				

Abbreviations:

LWT: Leaving water temperature (°C)

HC: Total heating capacity (W)

PI: Power input (W)

Notes:

1. Integrated heating capacity values take account of capacity drops caused by frost accumulation and during defrosting.

Table 2-4.4: KHC-30RX3 heating capacity - integrated values¹

Outdoor air temp. °C DB	LWT (°C)																					
	30			35			40			45			50			55			60			
	HC	PI	COP	HC	PI	COP	HC	PI	COP	HC	PI	COP	HC	PI	COP	HC	PI	COP	HC	PI	COP	
-25.0	8886	7322	1.21	8680	8019	1.08																
-20.0	11249	6302	1.79	10773	6901	1.56	10288	7500	1.37													
-15.0	17880	6930	2.58	17595	8523	2.06	16194	11075	1.46	14691	13737	1.07	14318	13687	1.05							
-10	22178	8749	2.53	21136	9400	2.25	20434	10862	1.88	19671	12377	1.59	18172	13423	1.35	14290	13635	1.05	10381	10223	1.02	
-7.0	23940	9425	2.54	23261	9927	2.34	22977	10735	2.14	22659	11561	1.96	21508	11943	1.80	16540	13786	1.20	12228	11043	1.11	
-5.0	24368	9278	2.63	23897	9874	2.42	23842	10779	2.21	23766	11708	2.03	22825	12188	1.87	18040	13480	1.34	13933	11348	1.23	
-2.0	25011	9301	2.69	24851	9795	2.54	25138	10846	2.32	25427	11928	2.13	23246	12272	1.89	19934	12793	1.56	17952	12818	1.40	
0	25440	8787	2.90	25487	9742	2.62	26003	10891	2.39	26534	12075	2.20	25278	12619	2.00	22724	13080	1.74	21611	13039	1.66	
2	24994	8075	3.10	26021	9085	2.86	25959	10220	2.54	28191	12317	2.29	26388	11998	2.20	24651	12493	1.97	23085	11821	1.95	
5	28738	8054	3.57	28531	8892	3.21	28875	9918	2.91	29219	10978	2.66	28825	11863	2.43	27846	13110	2.12	27000	13141	2.05	
7.0	31177	8100	3.85	31754	9509	3.34	30825	9810	3.14	30992	11268	2.75	31077	12097	2.57	30563	13819	2.21	27332	12943	2.11	
10	30030	7459	4.03	30099	8373	3.59	30837	9493	3.25	31579	10654	2.96	30903	11281	2.74	30172	11925	2.53	27033	11579	2.33	
15.0	31835	7396	4.30	32695	8637	3.79	34334	10108	3.40	36014	11636	3.09	34020	11332	3.00	32585	11237	2.90	27197	9762	2.79	
20.0	32636	7055	4.63	32977	8075	4.08	34150	9322	3.66	35340	10620	3.33	33608	10510	3.20	32477	10618	3.06	27137	9328	2.91	
25.0	33876	6869	4.93	33763	7710	4.38	34535	8776	3.94	35302	9885	3.57	33766	9942	3.40	32877	10226	3.22	27519	9093	3.03	
30.0	36747	7036	5.22	36198	7749	4.67	36587	8684	4.21	36947	9657	3.83	35488	9862	3.60	34721	10306	3.37	29225	9313	3.14	
35.0	12696	1782	7.12	12405	1972	6.29	12113	2161	5.61	11821	2351	5.03	11577	2665	4.34	11333	2979	3.80				

Abbreviations:

LWT: Leaving water temperature (°C)

HC: Total heating capacity (W)

PI: Power input (W)

Notes:

1. Integrated heating capacity values take account of capacity drops caused by frost accumulation and during defrosting.

Mono

4.2 Cooling Capacity Tables (Test standard: EN14511)

Table 2-4.5: KHC-22RX3 cooling capacity

Outdoor air temp.	LWT (°C)																							
	25			22			18			15			13			10			7			5		
°CDB	CC	PI	EER	CC	PI	EER	CC	PI	EER	CC	PI	EER	CC	PI	EER	CC	PI	EER	CC	PI	EER	CC	PI	EER
45	24059	5909	4.07	21857	5984	3.65	18920	6083	3.11	20753	7644	2.72	19982	8133	2.46	18394	8281	2.22	15755	8000	1.97	13996	7813	1.79
40	25547	5289	4.83	23508	5498	4.28	20790	5775	3.60	23278	7428	3.13	22791	8022	2.84	21085	8083	2.61	18179	7722	2.35	16242	7481	2.17
35	31695	5475	5.79	29498	5876	5.02	26568	6410	4.14	25804	7212	3.58	25600	7911	3.24	23775	7886	3.01	20873	7120	2.93	18938	6609	2.87
30	32805	4833	6.79	30457	5113	5.96	27325	5487	4.98	26491	6117	4.33	26249	6675	3.93	24797	6818	3.64	21925	6599	3.32	20011	6453	3.10
25	29567	3694	8.01	27392	3839	7.14	24491	4032	6.07	24706	4625	5.34	23846	4885	4.88	23026	5184	4.44	20716	5179	4.00	19176	5175	3.71
20	26423	3223	8.20	25189	3389	7.43	23542	3609	6.52	21581	3677	5.87	21775	3998	5.45	21025	4352	4.83	18773	4429	4.24	17272	4481	3.85
15	21288	2537	8.39	21105	2718	7.76	20861	2960	7.05	19239	2957	6.51	19671	3200	6.15	19292	3442	5.60	17399	3437	5.06	16138	3434	4.70
10	18223	2153	8.46	17097	2102	8.13	15597	2034	7.67	16079	2204	7.30	16770	2383	7.04	16794	2531	6.63						
5	14462	1734	8.34	13538	1686	8.03	12306	1622	7.59	13820	1911	7.23	14610	2093	6.98	14762	2241	6.59						
0	22126	2691	8.22	20667	2606	7.93	18721	2493	7.51	17261	2408	7.17	16288	2352	6.93	14829	2267	6.54						
-5	18833	3765	5.00	17543	3550	4.94	15824	3264	4.85	14535	3049	4.77	13675	2906	4.71	12386	2691	4.60						

Abbreviations:

LWT: Leaving water temperature (°C)

CC: Total cooling capacity (W)

PI: Power input (W)

Table 2-4.6: KHC-30RX3 cooling capacity

Outdoor air temp.	LWT (°C)																							
	25			22			18			15			13			10			7			5		
°CDB	CC	PI	EER	CC	PI	EER	CC	PI	EER	CC	PI	EER	CC	PI	EER	CC	PI	EER	CC	PI	EER	CC	PI	EER
45	24524	5595	4.38	22109	5778	3.83	18890	6023	3.14	20452	7705	2.65	18454	7857	2.35	18197	8596	2.12	16403	8680	1.89	15206	8736	1.74
40	26438	5410	4.89	24108	5726	4.21	21002	6148	3.42	27686	9586	2.89	25383	9898	2.56	24621	10227	2.41	22087	9866	2.24	20399	9625	2.12
35	34379	6180	5.56	33308	7240	4.60	31881	8653	3.68	35981	11591	3.10	33401	12107	2.76	30194	11214	2.69	29736	12705	2.34	29431	13699	2.15
30	41579	7118	5.84	38295	7474	5.12	33917	7949	4.27	38293	10380	3.69	35557	10677	3.33	35512	11169	3.18	31911	10593	3.01	29511	10210	2.89
25	44052	7030	6.27	40581	7121	5.70	35954	7244	4.96	36544	8253	4.43	35450	8692	4.08	33685	8912	3.78	30412	8762	3.47	28230	8662	3.26
20	38765	5925	6.54	35944	5916	6.08	32183	5904	5.45	30993	6223	4.98	30535	6544	4.67	30825	7350	4.19	25479	6850	3.72	21915	6516	3.36
15	32622	4756	6.86	30453	4670	6.52	27561	4554	6.05	26212	4612	5.68	26264	4837	5.43	25291	5020	5.04	22772	4920	4.63	21093	4853	4.35
10	28779	3984	7.22	27055	3834	7.06	24757	3635	6.81	25502	3859	6.61	25011	3869	6.46	24481	3929	6.23						
5	19577	3160	6.20	18535	3123	5.94	17145	2887	5.94	17712	2981	5.94	18488	3110	5.94	18674	3139	5.95						
0	24178	4426	5.46	23068	4559	5.06	21587	4131	5.23	20477	3809	5.38	19737	3595	5.49	18627	3273	5.69						
-5	28578	4067	7.03	26544	3815	6.96	23832	3478	6.85	21798	3225	6.76	20442	3057	6.69	18408	2804	6.56						

Abbreviations:

LWT: Leaving water temperature (°C)

CC: Total cooling capacity (W)

PI: Power input (W)

5 Operating Limits

Figure 2-5.1: Heating operating limits

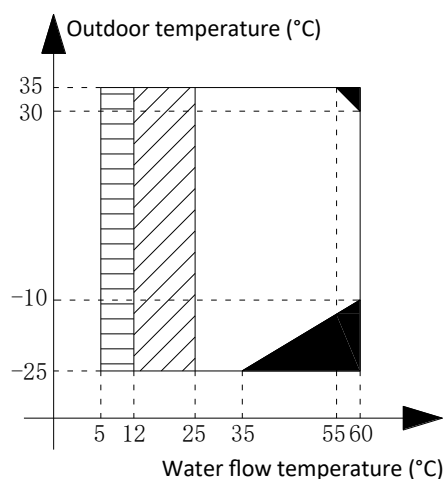

Figure 2-5.2: Cooling operating limits

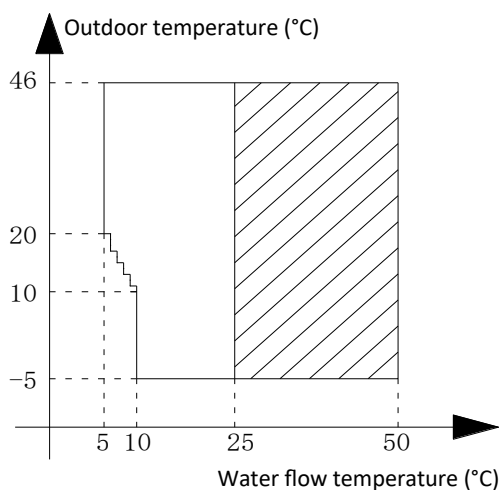
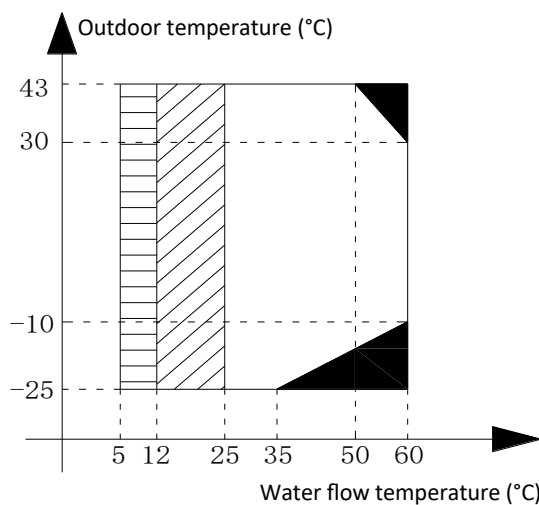

Figure 2-5.3: Domestic hot water operating limits



Notes:

- Shaded areas indicate no heat pump operation, IBH or AHS only.
- ▨ Shaded areas indicate water flow temperature drop or rise interval
- ▤ Shaded areas indicates if IBH/AHS setting is valid, only IBH/AHS turns on. If IBH/AHS setting is invalid, only heat pump turns on.

6 Hydronic Performance

Figure 2-6.1: KHC-22RX3, KHC-30RX3 hydronic performance¹

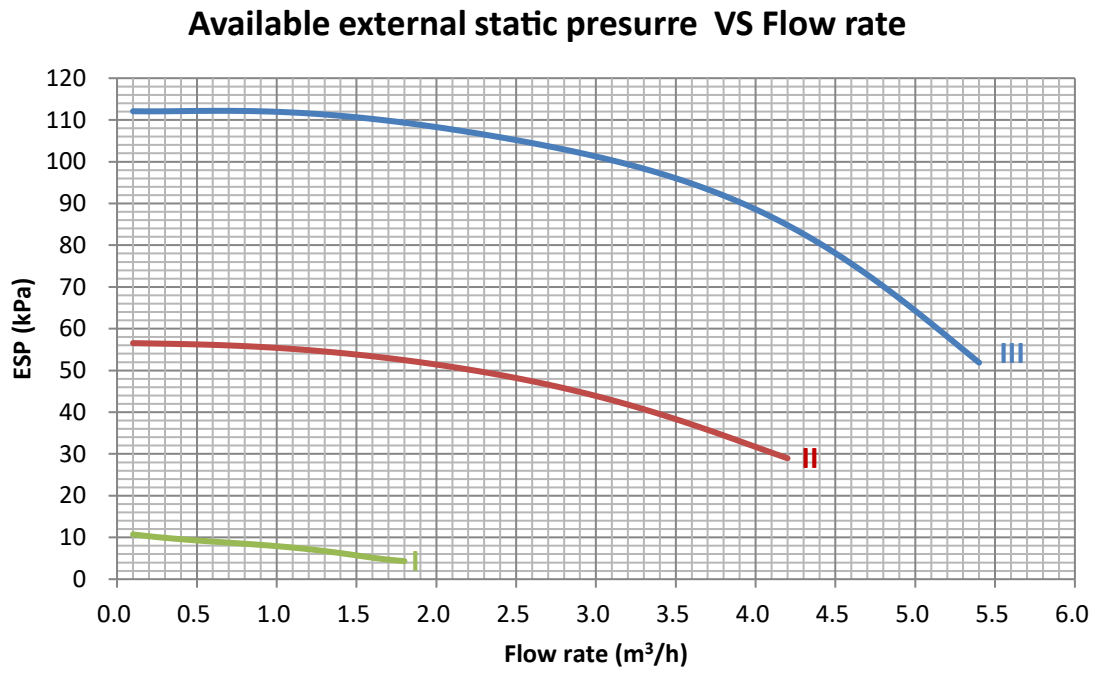

Abbreviations:

ESP: External static pressure

Notes:

1. I, II and III indicate water pump speed:
I: Low
II: Medium
III: High.

7 Sound Levels

7.1 Overall

Table 2-7.1: Sound pressure levels¹

Model name	dB(A) ²
KHC-22RX3	59.8
KHC-30RX3	63.5

Notes:

1. Sound pressure level is measured at a position 1m in front of the unit and $(1+H)/2$ m (where H is the height of the unit) above the floor in a semi-anechoic chamber. During in-situ operation, sound pressure levels may be higher as a result of ambient noise.

Figure 2-7.1: Sound pressure level measurement (unit: mm)

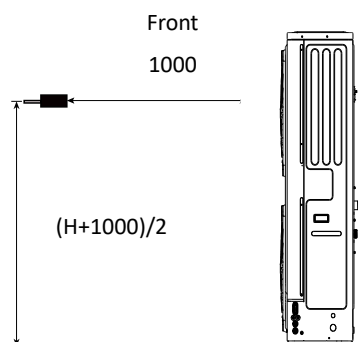

2. dB(A) is the maximum value tested under the conditions below:
 Outdoor air temperature 7°C DB, 85% R.H.; EWT 30°C, LWT 35°C.
 Outdoor air temperature 7°C DB, 85% R.H.; EWT 47°C, LWT 55°C.

Mono

7.2 Octave Band Levels

Figure 2-7.2: KHC-22RX3 octave band levels

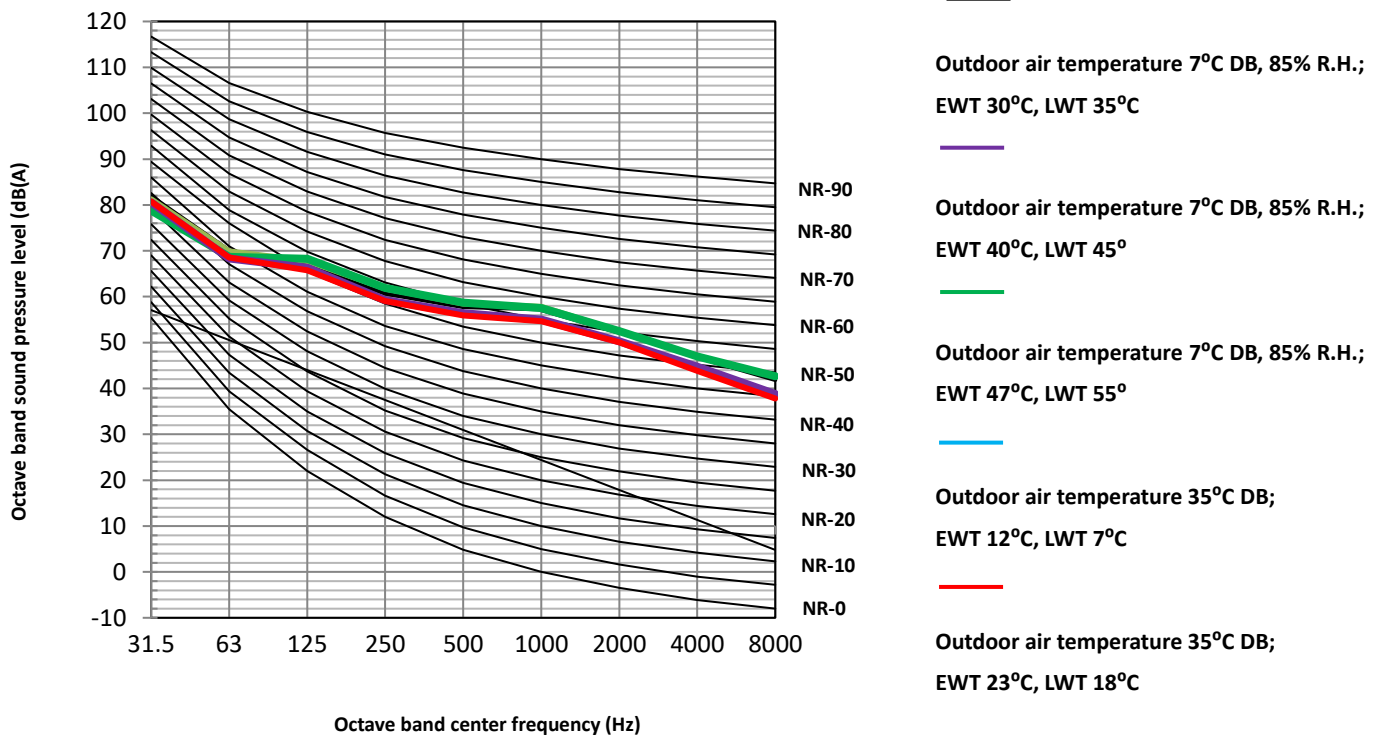
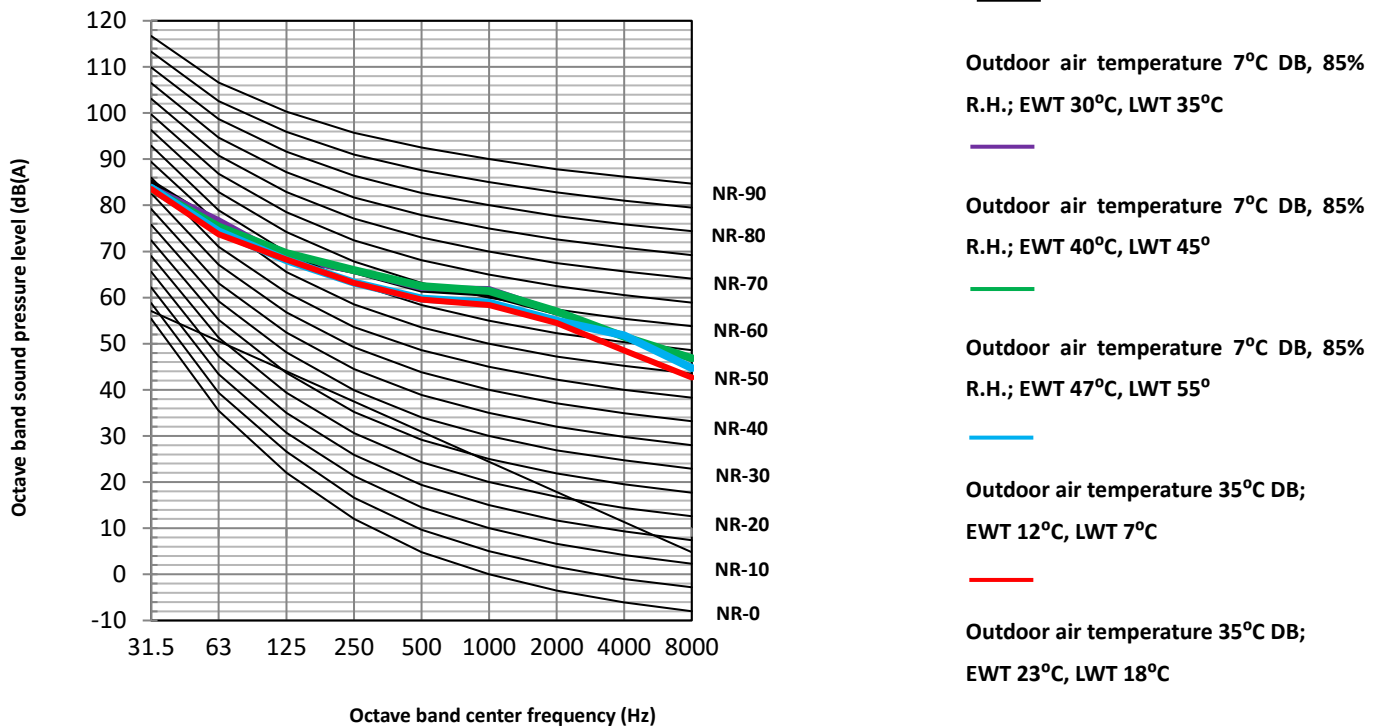











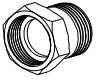

Figure 2-7.3: KHC-30RX3 octave band levels



8 Accessories

8.1 Standard accessories

Table 2-8.1: Standard accessories







Name	Shape	Quantity	Name	Shape	Quantity
Installation and owner's manual		1	Tighten belt for customer wiring use		2
Operation manual		1	Thermistor for domestic hot water tank(T5) *		1
Technical data manual		1	Extension wire for T5		1
Y-shaped filter		1	Network matching wire*		1
Water outlet connection pipe assembly		2	Adapter for inlet water pipe		1
Wired controller		1			

*Note:

When the units are connected in parallel, such as when the communication between the unit is unstable (such as Hd fault code), add a network matching wire between the ports H1 and H2 at the terminal of the communication system.

8.2 Optional Accessories

Table 2-8.2: Standard accessories

Name	Shape	Quantity			
Thermistor for balance tank(Tbt1)		1	Extension wire for Tbt1		1
Thermistor for Zone 2 flow temp. (Tw2)		1	Extension wire for Tw2		1
Thermistor for solar temp. (Tsolar)		1	Extension wire for Tsolar		1

Note:

1. If the system is installed in parallel, Tbt1 must be connected and installed in the balance tank.
2. Sensor Tbt1, T5 and extension wire can be shared, sensors Tw2, Tsolar and extension wire can be shared. If these functions are needed at the same time, please customize these sensors and extension wire additionally.

Part 3

Installation and Field Settings

1	Preface to Part 3	36
2	Installation	37
3	Water Pipework.....	42
4	Electrical Wiring.....	46
5	DIP Switch Settings	48
6	Internal Circulation Pump Speed Settings	49
7	User Interface Field Settings	51
8	Operation parameter	70
9	Network Configuration Guidelines.....	71
10	USB function guidelines.....	76
11	Appendix	78
12	Error Code Table	81

1 Preface to Part 3

1.1 Notes for Installers Boxes

The information contained in this Engineering Data Book may primarily be of use during the system design stage of a Mono project. Additional important information which may primarily be of use during field installation has been placed in boxes, such as the example below, titled “Notes for installers”.

Notes for installers



- Notes for installers boxes contain important information which may primarily be of use during field installation, rather than during desk-based system design.

1.2 Definitions

In this Engineering Data Book, the term “applicable legislation” refers to all national, local and other laws, standards, codes, rules, regulations and other legislation that apply in a given situation.

1.3 Precautions

All system installation including installation of water piping and electrical works must only be carried out by competent and suitably qualified, certified and accredited professionals and in accordance with all applicable legislation.

2 Installation

2.1 Acceptance and Unpacking

Notes for installers



- When units are delivered check whether any damage occurred during shipment. If there is damage to the surface or outside of a unit, submit a written report to the shipping company.
- Check that the model, specifications and quantity of the units delivered are as ordered.
- Check that all accessories ordered have been included. Retain the Owner's Manual for future reference.

2.2 Hoisting

Notes for installers



- Do not remove any packaging before hoisting. If units are not packaged or if the packaging is damaged, use suitable boards or packing material to protect the units.
- Hoist one unit at a time, using two ropes to ensure stability.

Figure 3-2.1: Hoisting the unit

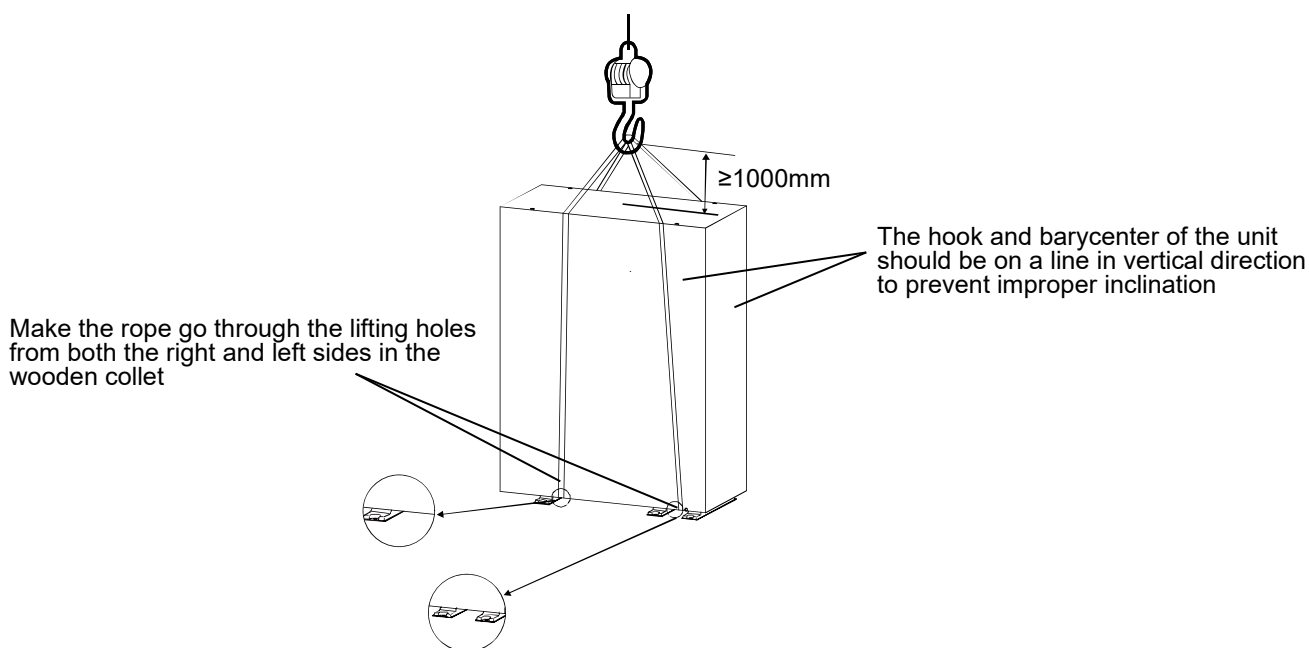

2.3 Placement Considerations

Placement of the outdoor unit should take account of the following considerations:

- Outdoor units should not be exposed to direct radiation from a high-temperature heat source or a potentially explosive atmosphere. Outdoor units should be installed in positions that are as far as possible to the heat emitters.
- Outdoor units should not be installed in positions often used as a work space. In case of construction work (e.g. grinding etc.) where dust or dirt is created and it may affect heat exchangers.
- Outdoor units should not be installed in locations where exposure to oil or to corrosive or harmful gases, such as acidic or alkaline gases, may occur.
- Outdoor units should be installed in well-drained, well-ventilated positions.
- Outdoor units should be installed in positions that are sufficiently close to the desired position of the wired controller

Mono

that the controller's wiring length limitation will not be exceeded.

- In systems that are configured to heat domestic hot water and/or include an external backup electric heater, outdoor units should be installed in positions that are sufficiently close to the domestic hot water tank and/or backup electric heater that the piping and temperature sensor wiring length come within the allowable ranges.
- Outdoor units should be installed in locations where the noise from the unit will not disturb neighbors.
- Outdoor units should be installed in safe places which can bear the unit's weight and vibration and where the unit can be installed at an even level.
- Outdoor units should be installed in positions that there is no possibility of flammable gas or product leak.
- Outdoor units should be installed in positions where servicing space can be well ensured.
- Outdoor units should be installed in positions where rain can be avoided as much as possible.

Outdoor units should be installed in clean area in case of small animals making contact with electrical parts, which can cause malfunction, smoke or fire.

There is flammable refrigerant in the unit and it should be installed in a well-ventilated site. If the unit is installed inside, an additional refrigerant detection device and ventilation equipment must be added in accordance with the standard EN378.

Adequate measures should be adopted to prevent the unit from being used as a shelter by small animals.

2.4 Strong Wind Installation

Wind of 5m/s or more blowing against an outdoor unit's air outlet blocks the flow of air through the unit, leading to deterioration in unit capacity, accelerated frost accumulation when in heating mode or domestic hot water mode, and potential disruption to operation due to increased pressure in the refrigerant circuit. Exposure to very strong wind can also cause the fan to rotate excessively fast, potentially leading to damage to the fan. In locations where exposure to high winds may occur should take account of the following considerations:

- Set the outlet side at a right angle to the direction of the wind, refer to Figure 3-2.2. For installation of the outdoor unit in a place where the wind direction can be foreseen, refer to Figure 3-2.3 for installation of the unit.
- If turn the air outlet side toward the building's wall, fence or screen. Make sure there is enough room to do the installation

Figure 3-2.2: Strong wind installation direction

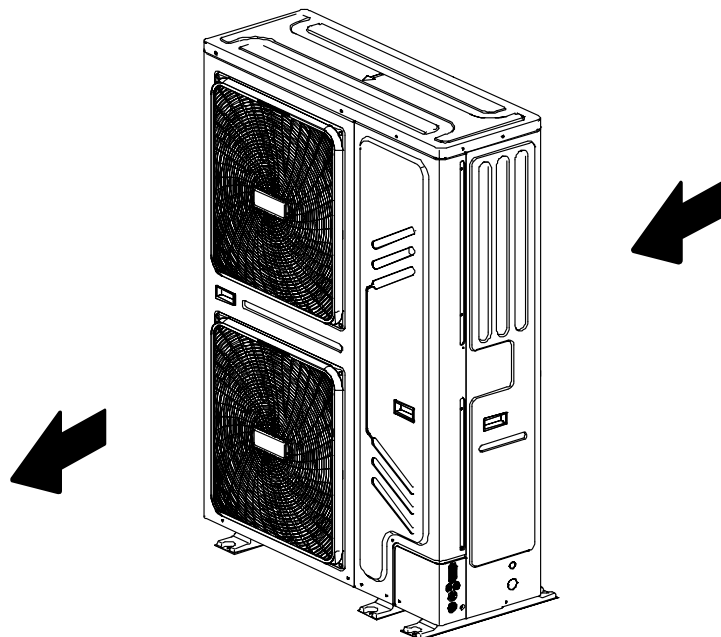
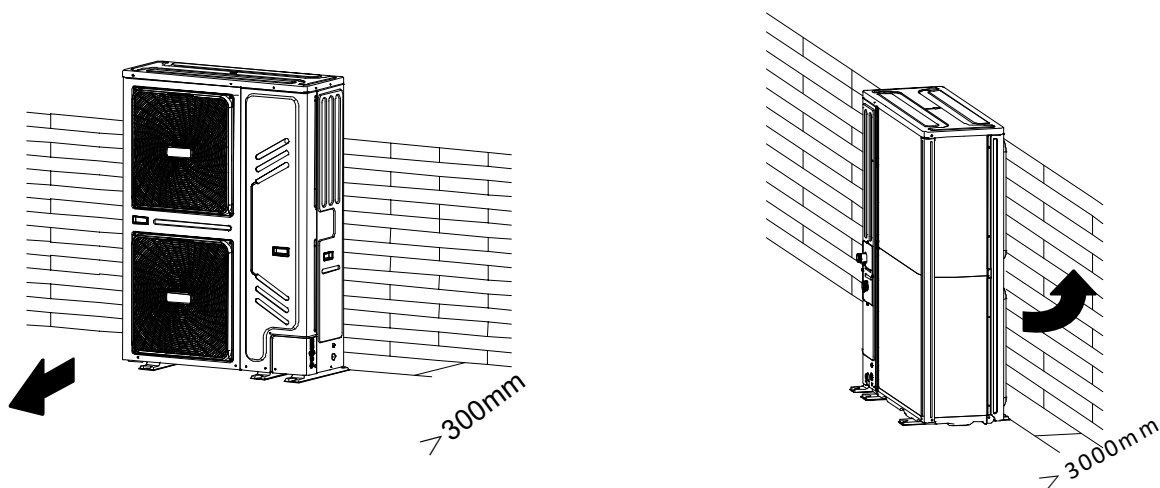

Figure 3-2.3: Installation room illustration



2.5 Cold Climate Installation

In cold climate locations installation should take account of the following considerations:

- Never install the unit at a site where the suction side may be exposed directly to wind.
- To prevent exposure to wind, install a baffle plate on the air discharge side of the unit.
- To prevent exposure to wind, install the unit with its suction side facing the wall.
- In areas of heavy snowfall, a canopy should be installed to prevent snow entering the unit. Additionally, the height of the base structure should be increased so as to raise the unit further off the ground and make sure that the heat exchanger coil is not affected by the snow. Refer to Figure 3-2.4.

Notes:

- ① Construct a large canopy.
- ② Construct a pedestal

Install the unit high enough off the ground to prevent it from being buried in snow

2.6 Hot Climate Installation

As the outdoor temperature is measured via the outdoor ambient temperature sensor, make sure to install the outdoor unit in the shade, or a canopy should be constructed to avoid direct sunlight. So that it is not influenced by the sun's heat, otherwise system protection may occur.

2.7 Base Structure

Outdoor unit base structure design should take account of the following considerations:

- A solid base prevents excess vibration and noise. Outdoor unit bases should be constructed on solid ground or on structures of sufficient strength to support the unit's weight.
- Bases should be at least 100mm high to provide sufficient drainage and to prevent water ingress into the base of the unit.
- Either steel or concrete bases may be suitable.
- Outdoor units should not be installed on supporting structures that could be damaged by water build-in in the event of a blocked drain.
- Fix the unit securely to foundation by means of the $\Phi 10$ expansion bolt. It is best to screw in the foundation bolts until their length is 20 mm from the foundation surface.

Figure 3-2.4: Snow shielding

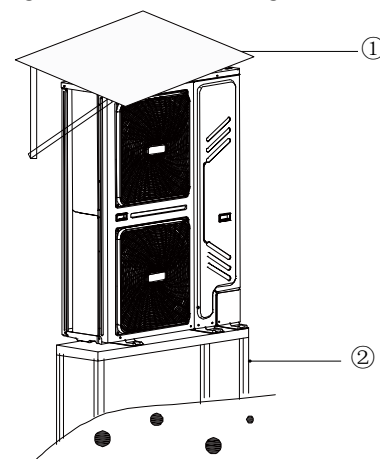
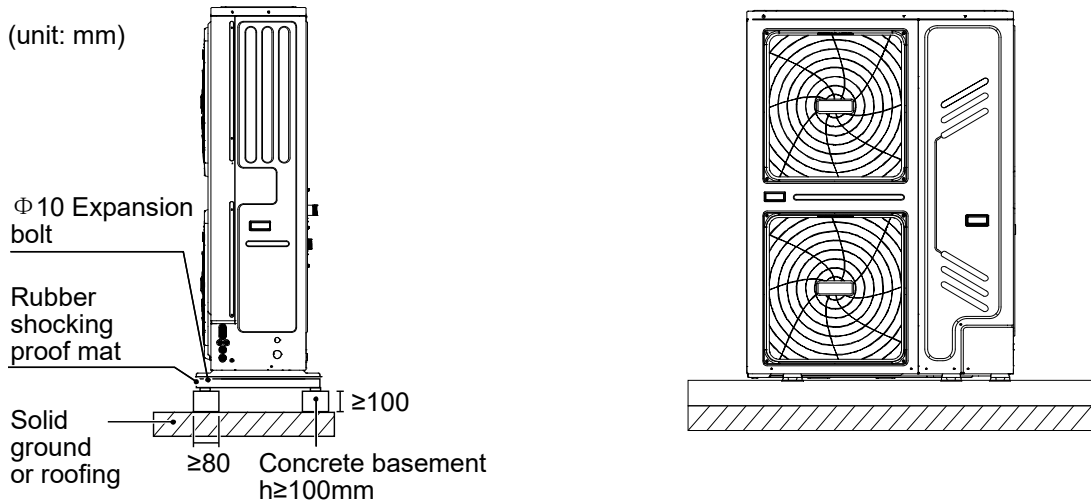

Figure 3-2.5: Outdoor unit typical concrete base structure design (unit: mm)



2.8 Drainage

Drainage ditch should be provided to allow drainage of condensate that may form on the air side heat exchanger when the unit is running in heating mode or domestic hot water mode. The drainage should ensure that condensate is directed away from roadways and footpaths, especially in locations where the climate is such that condensate may freeze.

Figure 3-2.6: Drainage hole

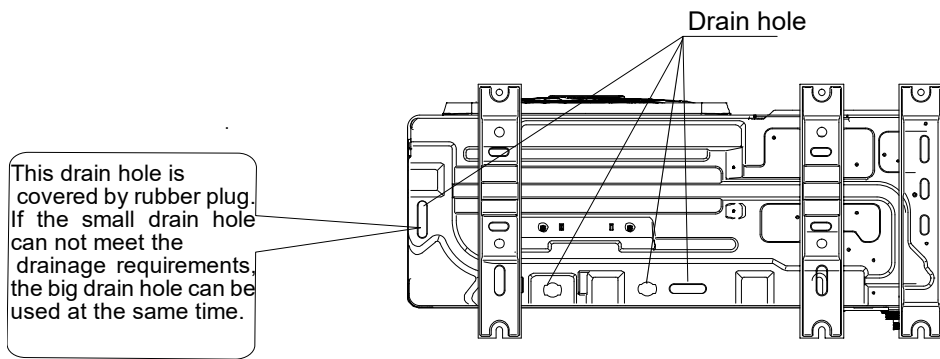

2.9 Spacing

Outdoor units must be spaced such that sufficient air may flow through each unit. Sufficient airflow across heat exchangers is essential for outdoor units to function properly. For more details please refer to the figures below.

Figure 3-2.7: Single unit installation

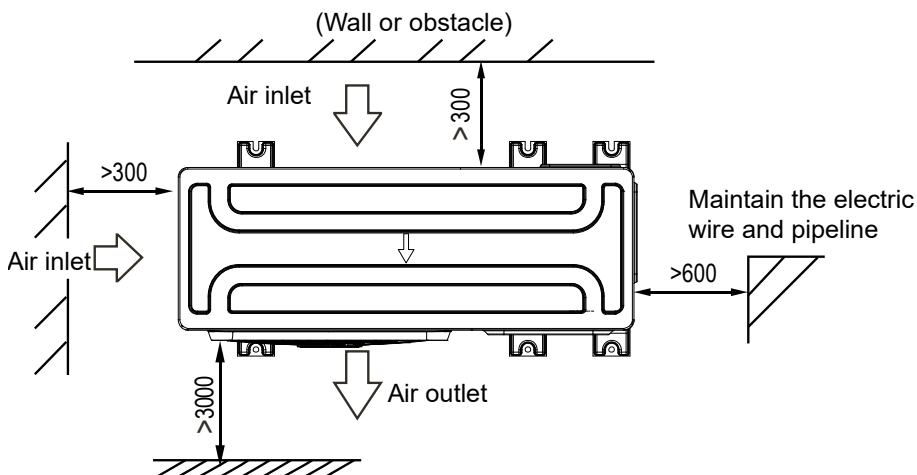

Figure 3-2.8: Parallel connect the two units or above

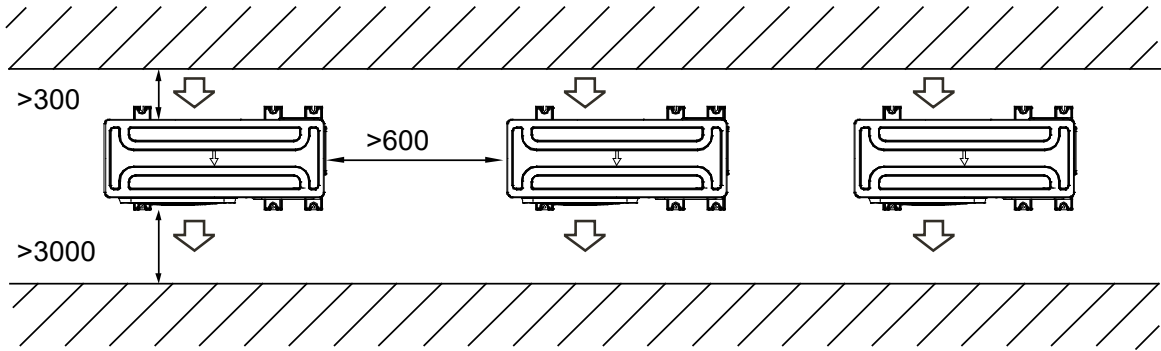
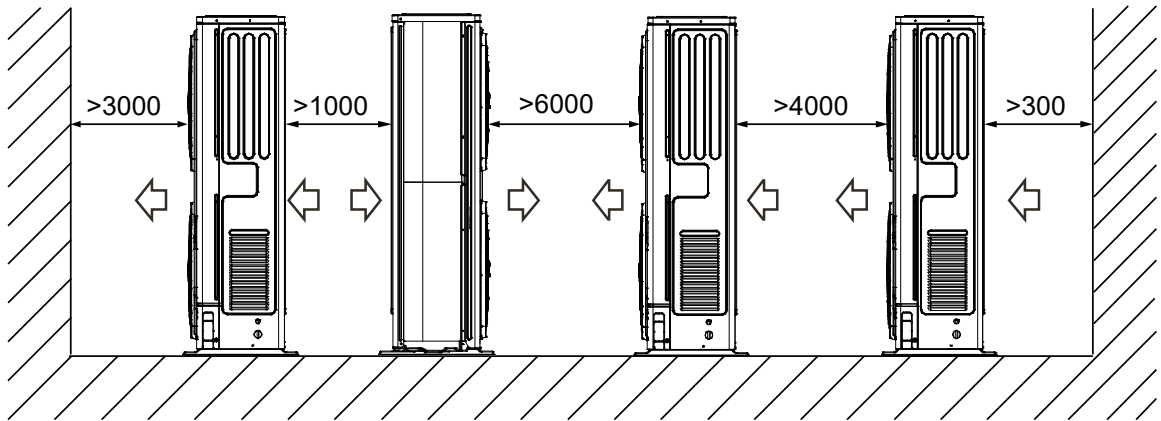

Figure 3-2.9: Parallel connect the front with rear sides



3 Water Pipework

3.1 Water Circuit Checks

Mono units are equipped with a water inlet and outlet for connection to a water circuit. Mono units should only be connected to closed water circuits. Connection to an open water circuit would lead to excessive corrosion of the water piping. Only materials complying with all applicable legislation should be used.

Before continuing installation of the unit, check the following:

- The maximum water pressure ≤ 3 bar.
- The maximum water temperature $\leq 70^{\circ}\text{C}$ according to safety device setting.
- Always use materials that are compatible with the water used in the system and with the materials used in the unit.
- Ensure that components installed in the field piping can withstand the water pressure and temperature.
- Drain taps must be provided at all low points of the system to permit complete drainage of the circuit during maintenance.
- Air vents must be provided at all high points of the system. The vents should be located at points that are easily accessible for service. An automatic air purge is provided inside the unit. Check that this air purge valve is not tightened so that automatic release of air in the water circuit is possible.

3.2 Water Volume and Expansion Vessel Pre-pressure Checks

Outdoor units are equipped with an expansion vessel (8L) that has a default pre-pressure of 1.0 bar. To assure proper operation of the unit, the pre-pressure of the expansion vessel might need to be adjusted.

Table 3-3.1: Expansion vessel pre-pressure adjustment

Installation height difference ¹	Water volume ≤ 230 L	Water volume > 230 L
≤ 7 m	No pre-pressure adjustment required	Actions required: <ul style="list-style-type: none"> • Pre-pressure must be decreased, calculate according to "Calculating the pre-pressure of the expansion vessel"² • Check if the water volume is lower than maximum allowed water volume (refer to Figure 3-3.1)
> 7 m	Actions required: <ul style="list-style-type: none"> • Pre-pressure must be increased, calculate according to "Calculating the pre-pressure of the expansion vessel"² • Check if the water volume is lower than maximum allowed water volume (refer to Figure 3-3.1) 	Expansion vessel in the outdoor unit too small for the system. An external expansion vessel (field supplied) is required.

Notes:

1. Height difference is between the highest point of the water circuit and the outdoor unit's expansion tank. Unless the unit is located at the highest point of the system, in which case the installation height difference is considered to be zero.
2. Calculating the pre-pressure of the expansion vessel:
The pre-pressure (P_g) to be set depends on the maximum installation height difference (H) and is calculated as $P_g(\text{bar}) = (H(\text{m})/10 + 0.3)$ bar

To determine the maximum allowed water volume in the entire circuit, proceed as follows:

- Determine the calculated pre-pressure (P_g) for the corresponding maximum water volume using the Figure 3-3.1.

Figure 3-3.1: Maximum water volume

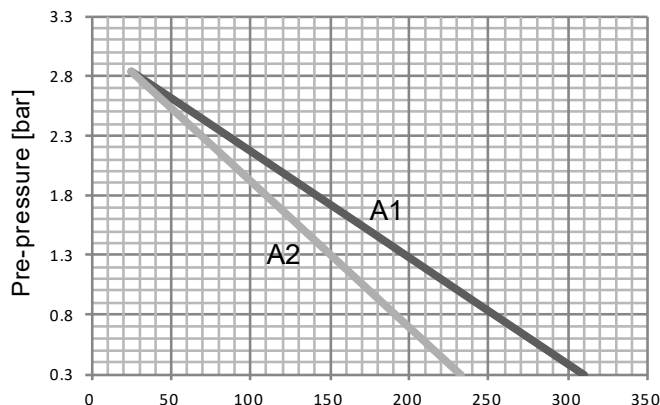

A1: System without glycol

A2: System with 25% propylene glycol

Pre-pressure = pre-pressure of the expansion vessel

Maximum water volume = maximum water volume in the system

- Check that the total water volume in the entire water circuit is lower than this value. If this is not the case, the expansion vessel inside the unit is too small for the installation.

Example 1

The unit is installed 5m below the highest point in the water circuit. The total water volume in the water circuit is 100 L. In this example, no action or adjustment is required.

Example 2

The unit is installed at the highest point in the water circuit. The total water volume in the water circuit is 250L.

Result:

- Since 250 L is more than 230 L, the pre-pressure must be decreased.
- The required pre-pressure is: $P_g(\text{bar}) = (H(\text{m})/10 + 0.3) \text{ bar} = (0/10 + 0.3) \text{ bar} = 0.3 \text{ bar}$
- The corresponding maximum water volume can be read from the graph: approximately 310L.
- Since the total water volume (250L) is below the maximum water volume (310L), the expansion vessel suffices for the installation.

When it is required to change the default pre-pressure of the expansion vessel (1.0 bars), following guidelines:

- Use only dry nitrogen to set the expansion vessel pre-pressure.
- Inappropriate setting of the expansion vessel pre-pressure will lead to malfunctioning of the system. Pre-pressure should only be adjusted by a licensed installer.

If the expansion vessel of unit is too small for the installation, an additional expansion vessel is needed.

- Calculate the pre-pressure of the expansion vessel: $P_g(\text{bar}) = (H(\text{m})/10 + 0.3) \text{ bar}$
The expansion vessel equipped in the unit should adjust the pre-pressure also.
- Calculate the volume needed of the additional expansion vessel: $V_1 = 0.0693 * V_{\text{water}} / (2.5 - P_g) - V_0$
 V_{water} : the volume of water in the system
 V_0 : the volume of expansion vessel which the unit is equipped (8L)

3.3 Water Circuit Connection

Water connections must be made correctly in accordance with the labels on the outdoor unit, with respect to the water inlet and water outlet. If air, moisture or dust gets in the water circuit, problems may occur. Therefore, always take into account the following when connecting the water circuit:

- Use clean pipes only.
- Hold the pipe end downwards when removing burrs

Mono

- Cover the pipe end when inserting it through a wall to prevent dust and dirt entering.
- Use a good thread sealant for sealing the connections. The sealing must be able to withstand the pressures and temperatures of the system.
- When using non-copper metallic piping, be sure to insulate the two kind of materials from each other to prevent galvanic corrosion.
- For copper is a soft material, use appropriate tools for connecting the water circuit. Inappropriate tools will cause damage to the pipes

3.4 Water Circuit Anti-freeze Protection

Ice formation can cause damage to the hydronic system. All internal hydronic parts are insulated to reduce heat loss. Insulation must also be added to the field piping.

- The software contains special functions using the heat pump to protect the entire system against freezing. When the temperature of the water flow in the system drops to a certain value, the unit will heat the water, either using the heat pump, or the backup heater. The freeze protection function will turn off only when the temperature increases to a certain value.
- In event of a power failure, the above features would not protect the unit from freezing. Since a power failure could happen when the unit is unattended, the supplier recommends use anti-freeze fluid to the water system.

Depending on the expected lowest outdoor temperature, make sure the water system is filled with a concentration of glycol as mentioned in the table below. When glycol is added to the system, the freezing point of water will be lower and the performance of the unit will be affected. The correction factor of the unit capacity, flow rate and pressure drop of the system is listed in the table 3-3.2 and 3-3.3.

Table 3-3.2: Ethylene Glycol

Concentration of ethylene glycol (%)	Modification coefficient				Minimum outdoor temperature(°C)
	Cooling capacity modification	Power modification	Water resistance	Water flow modification	
0	1.000	1.000	1.000	1.000	0
10	0.984	0.998	1.118	1.019	-5
20	0.973	0.995	1.268	1.051	-15
30	0.965	0.992	1.482	1.092	-25

Table 3-3.3: Propylene Glycol (including the necessary inhibitors, classified as Category III according to EN1717)

Concentration of propylene glycol (%)	Modification coefficient				Minimum outdoor temperature (°C)
	Cooling capacity modification	Power modification	Water resistance	Water flow modification	
0	1.000	1.000	1.000	1.000	0
10	0.976	0.996	1.071	1.000	-4
20	0.961	0.992	1.189	1.016	-12
30	0.948	0.988	1.380	1.034	-20

Glycol absorbs water from its environment. Therefore do NOT add glycol that has been exposed to air. Leaving the cap off the glycol container causes the concentration of water to increase. The glycol concentration is then lower than assumed. As a result, the hydraulic components might freeze up after all. Take preventive actions to ensure a minimal exposure of the glycol to air.

Due to the presence of glycol, corrosion of the system is possible. Uninhibited glycol will turn acidic under the influence of oxygen. This process is accelerated by presence of copper and at higher temperatures. The acidic uninhibited glycol attacks metal surfaces and forms galvanic corrosion cells that cause severe damage to the system. It is of extreme importance:

- That the water treatment is correctly executed by a qualified water specialist.
- That a glycol with corrosion inhibitors is selected to counteract acids formed by the oxidation of glycols.
- That in case of an installation with a domestic hot water tank, only the use of propylene glycol is allowed. If the system does NOT contain a domestic hot water tank, then you can use either propylene glycol or ethylene glycol;
- That no automotive glycol is used because their corrosion inhibitors have a limited lifetime and contain silicates that can foul or plug the system;
- That galvanized piping is not used in glycol systems since it may lead to the precipitation of certain elements in the glycol's corrosion inhibitor;
- To ensure that the glycol is compatible with the materials used in the system.
- Protection against bursting: the glycol will prevent the piping from bursting, but NOT the liquid inside the piping from freezing.
- Protection against freezing: the glycol will prevent the liquid inside the piping from freezing.
- The required concentration might differ depending on the type of glycol. ALWAYS compare the requirements from the table above with the specifications provided by the glycol manufacturer. If necessary, meet the requirements set by the glycol manufacturer.
- If the liquid in the system is frozen, the pump will NOT be able to start. Mind that if you only prevent the system from bursting, the liquid inside might still freeze.
- When water is at standstill inside the system, the system is very likely to freeze and get damaged.

3.5 Water Flow Switch

Water may enter into the flow switch and cannot be drained out and may freeze when the temperature is low enough. The flow switch should be removed and dried, then can be reinstalled in the unit.

- Counterclockwise rotation, remove the water flow switch.
- Drying the water flow switch completely.

Figure 3-3.2: Water flow switch

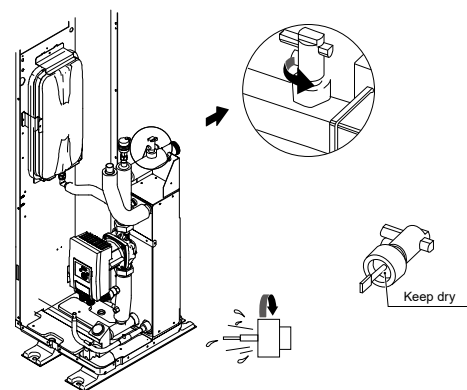

3.6 Adding Water

- Connect the water supply to the fill valve and open the valve.
- Make sure the automatic air purge valve is open (at least 2 turns). Refer to Figure 3-3.3.
- Fill with water until the manometer indicates a pressure of approximately 2.0 bars. Remove air in the circuit as much as possible using the air purge valve. Air in the water circuit could lead to malfunction of the backup electric heater.

Figure 3-3.3: Air purge valve

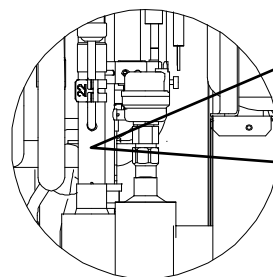

Do not fasten the black plastic cover on the vent valve at the topside of the unit when the system is running. Open air purge valve, turn anticlockwise at least 2 full turn to release air from the system.

3.7 Water Piping Insulation

The complete water circuit including all piping, water piping must be insulated to prevent condensation during cooling operation and reduction of the heating and cooling capacity as well as prevention of freezing of the outside water piping during winter. The insulation material should at least of B1 fire resistance rating and complies with all applicable legislation. The thickness of the sealing materials must be at least 13mm with thermal conductivity 0.039W/mK in order to prevent freezing on the outside water piping. If the outdoor ambient temperature is higher than 30°C and the humidity is higher than RH 80%, the thickness of the sealing materials should be at least 20mm in order to avoid condensation on the surface of the seal.

4 Electrical Wiring

4.1 General

Notes for installers



Caution

- All installation and wiring must be carried out by competent and suitably qualified, certified and accredited professionals and in accordance with all applicable legislation.
- Electrical systems should be grounded in accordance with all applicable legislation.
- Overcurrent circuit breakers and residual-current circuit breakers (ground fault circuit interrupters) should be used in accordance with all applicable legislation.
- Wiring patterns shown in this data book are general connection guides only and are not intended for, or to include all details for, any specific installation.
- The water piping, power wiring and communication wiring are typically run in parallel. However the communication wiring should not be bound together with power wiring. To prevent signal interference, the power wiring and communication wiring should not be run in the same conduit. If the power supply is less than 10A, a separation of at least 300mm between power wiring and communication wiring conduits should be maintained; if the power supply is in the range 10A to 50A then a separation of at least 500mm should be maintained.

4.2 Precautions

- Fix cables so that cables do not make contact with the pipes (especially on the high pressure side).
- Secure the electrical wiring with cable ties as shown in Figure 3-1.14 and Figure 3-1.15. So that it does not come in contact with the piping, particularly on the high-pressure side.

Figure 3-4.1: Wiring hole locations

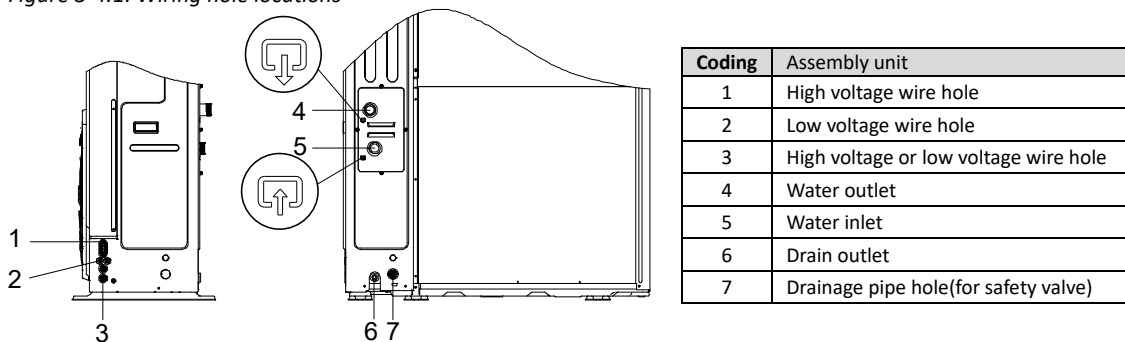

- Make sure no external pressure is applied to the terminal connectors.
- When installing the ground fault circuit interrupter make sure that it is compatible with the inverter (resistant to high frequency electrical noise) to avoid unnecessary opening of the ground fault circuit interrupter.
- This unit is equipped with an inverter. Installing a phase advancing capacitor not only reduce the power factor improvement effect, but also may cause abnormal heating of the capacitor due to high frequency waves. Never install a phase advancing capacitor as it could lead to an accident.

4.3 Guidance

- Most field wiring on the unit is to be made on the terminal block inside the switch box. To gain access to the terminal block, remove the switch box service panel.
- Fix all cables using cable ties.

- A dedicated power circuit is required for the backup electric heater.
- Installation equipped with a domestic hot water tank (field supplied) requires a dedicated power circuit for the immersion heater.
- Lay out the electrical wiring so that the front cover does not rise up when doing wiring work and attach the front cover securely.
- Follow the electric wiring diagrams for electrical wiring works. Refer to Figure 2-4.1 in part 2, 4 “Wiring Diagram”.
- Install the wires and fix the cover firmly so that the cover may be fit in properly.

4.4 Wiring Overview

Figure 3-4.2: Wiring overview

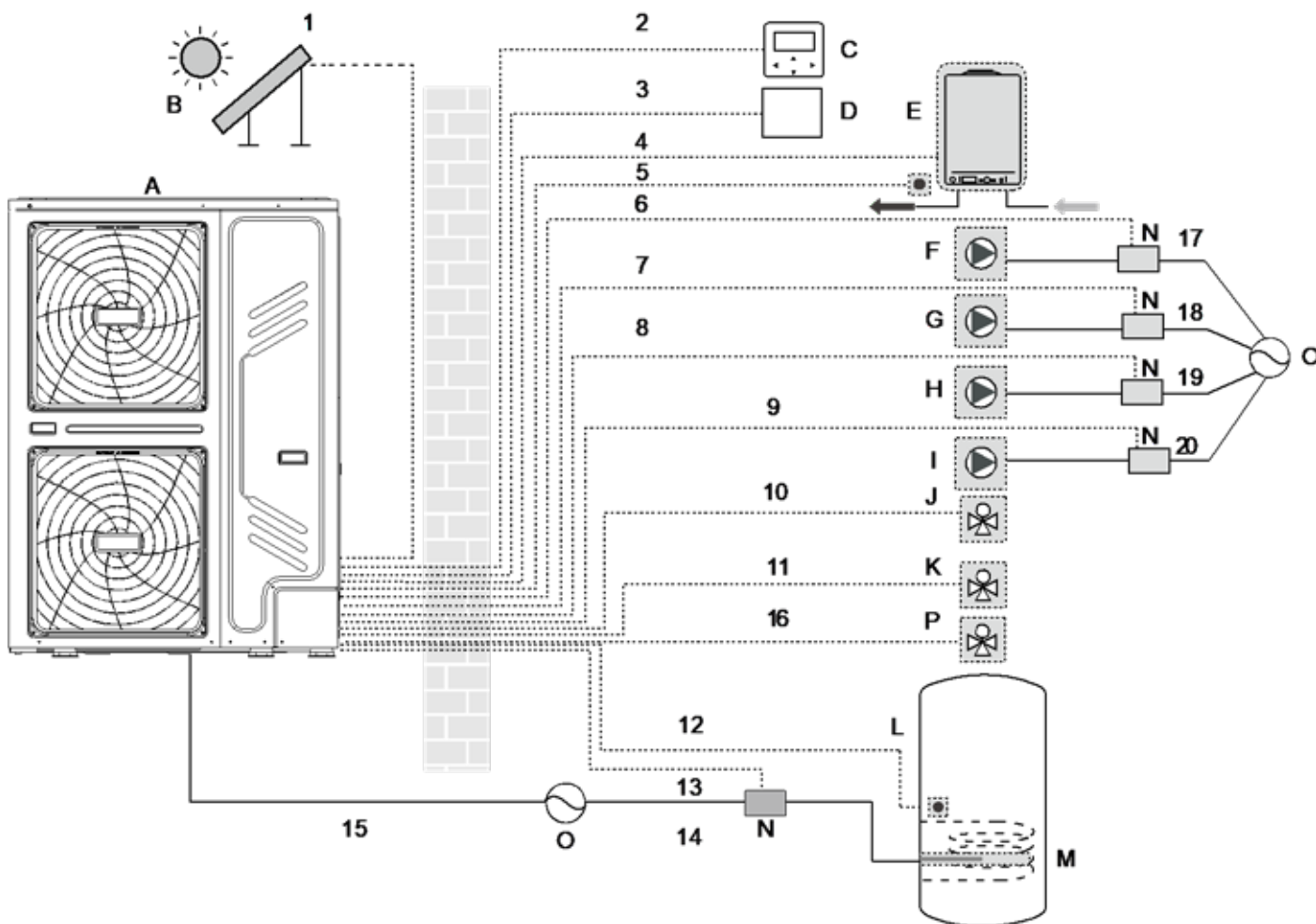

Legend			
A	Outdoor unit	I	P_d: DHW pump (field supplied)
B	Solar panel (field supplied)	J	SV2: 3-way valve (field supplied)
C	Wired controller	K	SV1: 3-way valve for domestic hot water tank(field supplied)
D	Room thermostat (field supplied)	L	Domestic water tank (field supplied)
E	AHS (field supplied)	M	Booster heater (field supplied)
F	P_s: Solar pump (field supplied)	N	Contactors (field supplied)
G	P_c: Circulation pump / zone 2 pump (field supply)	O	Power supply
H	P_o: Outside circulation pump / zone 1 pump (field supply)	P	SV3: 3-way valve for Zone 2 (field supplied)

Mono

Table 3-4.1: Wiring requirements

Item	Description	Current	Required number of conductors	Maximum running current
1	Solar energy kit signal wire	AC	2	200mA
2	User interface wire	AC	5	200mA
3	Room thermostat wire	AC	2 or 3	200mA ^a
4	Boiler control wire	/	2	200mA
5	Temperature sensor wire for Tw2	DC	2	b
9	Control wire for DHW PUMP	AC	2	200mA ^a
10	Control wire for 3-way valve	AC	2 or 3	200mA ^a
11	Control wire for 3-way valve	AC	2 or 3	200mA ^a
12	Temperature sensor wire for T5	DC	2	b
13	Control wire for booster heater	AC	2	200mA ^a
15	Power supply wire for outdoor unit	AC	3+GND	c
16	Control wire for 3-way valve	AC	2 or 3	200mA ^a

Notes:

- a. Minimum cable section AWG 18 (0.75mm²)
- b. The temperature sensor wire (10m) are delivered with zone 2 outlet tem. Tw2 and domestic hot water tank T5.
- c. See Table 3-4.2 for details.

Table 3-4.2: Outdoor unit power supply

Unit	22kW	30kW
Maximum overcurrent protector(MOP)	21	28
Wiring size(mm ²)	6	6

5 DIP Switch Settings

DIP switch is located on the hydraulic module main control board and allows configuration of additional heating source thermistor installation, the second inner backup heater installation, etc.

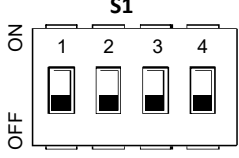
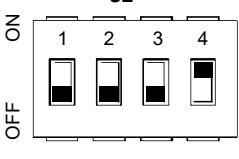
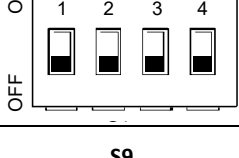
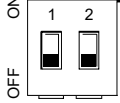
Switch		ON=1	OFF=0
 <p>S1</p>	1	Reserved	Reserved
	2	Reserved	Reserved
	3/4	00=Without IBH and AHS 10=With IBH 01=With AHS for heat mode 11=With AHS for heat mode and DHW mode	
 <p>S2</p>	1	Start pumpo after 24 hours will be invalid	Start pumpo after 24 hours will be valid
	2	without TBH	with TBH
	3/4	00=variable speed pump (Max head:8.5m) 01=constant speed pump 10=constant speed pump (Max head: 10.5m) 11=constant speed pump (Max head:9m)	
 <p>S4</p>	1	Master unit: clear address of all slave units Slave unit: clear its own address	Keep the current address
	2/3/4	Reserved	
 <p>S9</p>	1/2	00=Slave unit 11=Master unit	

6 Internal Circulation Pump Speed Settings

The internal circulation pump speed can be selected by adjusting the red knob on the pump. The default factory setting is the highest speed (III). If the system water flow is too high, the pump speed can be set to medium (II) or low (I). The relationship between external static pressure and water flow rate is described in Part 2, 7 “Hydronic Performance”.

Figure 3-6.1: Internal circulation pump

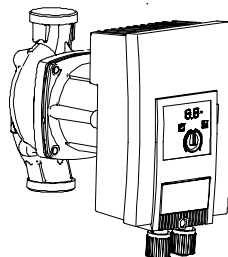

Figure 3-6.2: Faults with external interference sources

Faults	Causes	Remedy
Pump is not running although the power supply is switched on.	Electrical fuse defective.	Check fuses.
Black display.	Pump has no voltage	Restore power after interruption.
Pump is making noises.	Cavitation due to insufficient suction pressure.	Increase the system suction pressure within the permissible range.
		Check the delivery head setting and set to lower head if necessary.

▪ Fault signals

- The fault signal is indicated by the LED display .
- The fault signal LED is continuously illuminated in red .
- The pump switches off (depending on the error code), and attempts a cyclical restart. (Specially, for Error code E10 (blocking): After approx. 10 minutes, the pump switches off permanently and displays the error code.)

Figure 3-6.3: Fault signals

Code No.	Fault	Cause	Remedy
E04	Mains undervoltage	Power supply too low on mains side	Check mains voltage
E05	Mains overvoltage	Power supply too high on mains side	Check mains voltage
E09	Turbine operation	The pump is driven in reverse (the fluid flows through the pump from the pressure to the suction side)	Check flow, install non-return valves if necessary
E10	Blocking	The rotor is blocked	Request customer service
E21*	Overload	Sluggish motor	Request customer service
E23	Short-circuit	Motor current too high	Request customer service
E25	Contacting/winding	Motor winding defective	Request customer service
E30	Module overheated	Module interior too warm	Improve room ventilation, check operating conditions, request customer service, if necessary
E31	Overheated power section	Ambient temperature too high	Improve room ventilation, check operating conditions, request customer service, if necessary
E36	Electronic faults	Electronics defective	Request customer service

* In addition to the LED display, the fault signal LED is continuously illuminated in red.

Mono

- Warning signals
 - The warning signal is indicated by the LED display.
 - The fault signal LED and the SSM relay do not respond.
 - The pump continues to run with limited output.
 - The indicated faulty operating status must not occur for a prolonged period. The cause must be eliminated.

Figure 3-6.4: Warning signals

Code No.	Fault	Cause	Remedy
E07	Generator operation	Pump hydraulics have fluid running through them.	Check the system
E11	Dry running	Air in the pump	Check the water volume/ pressure
E21*	Overload	Sluggish motor, pump is operated outside of its specifications (e.g. high module temperature). The speed is lower than during normal operation.	Check the ambient conditions

* In addition to the LED display, the fault signal LED is continuously illuminated in red.

- In order to ensure the service life of the pump, it is recommended that the unit run at least once every 2 weeks (ensure that the pump is running) or keep it powered on for a long time (in the power-on standby state, the unit will run the pump for 3 minutes every 6 hours)

7 User Interface Field Settings

7.1 Introduction

During installation, the heat pump settings and parameters should be configured by the installer to suit the installation configuration, climate conditions and end-user preferences. The relevant settings are accessible and programmable through the **FOR SERVICEMAN** menu on the user interface. The user interface menus and settings can be navigated using the user interface’s touch-sensitive keys, as detailed in Table 3-7.1.

Figure 3-7.1: User interface

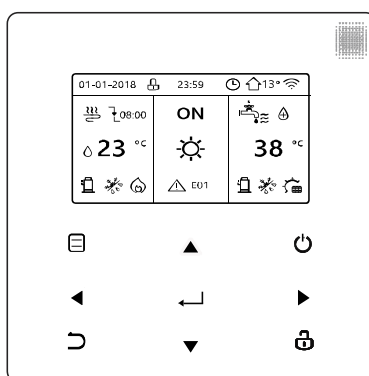
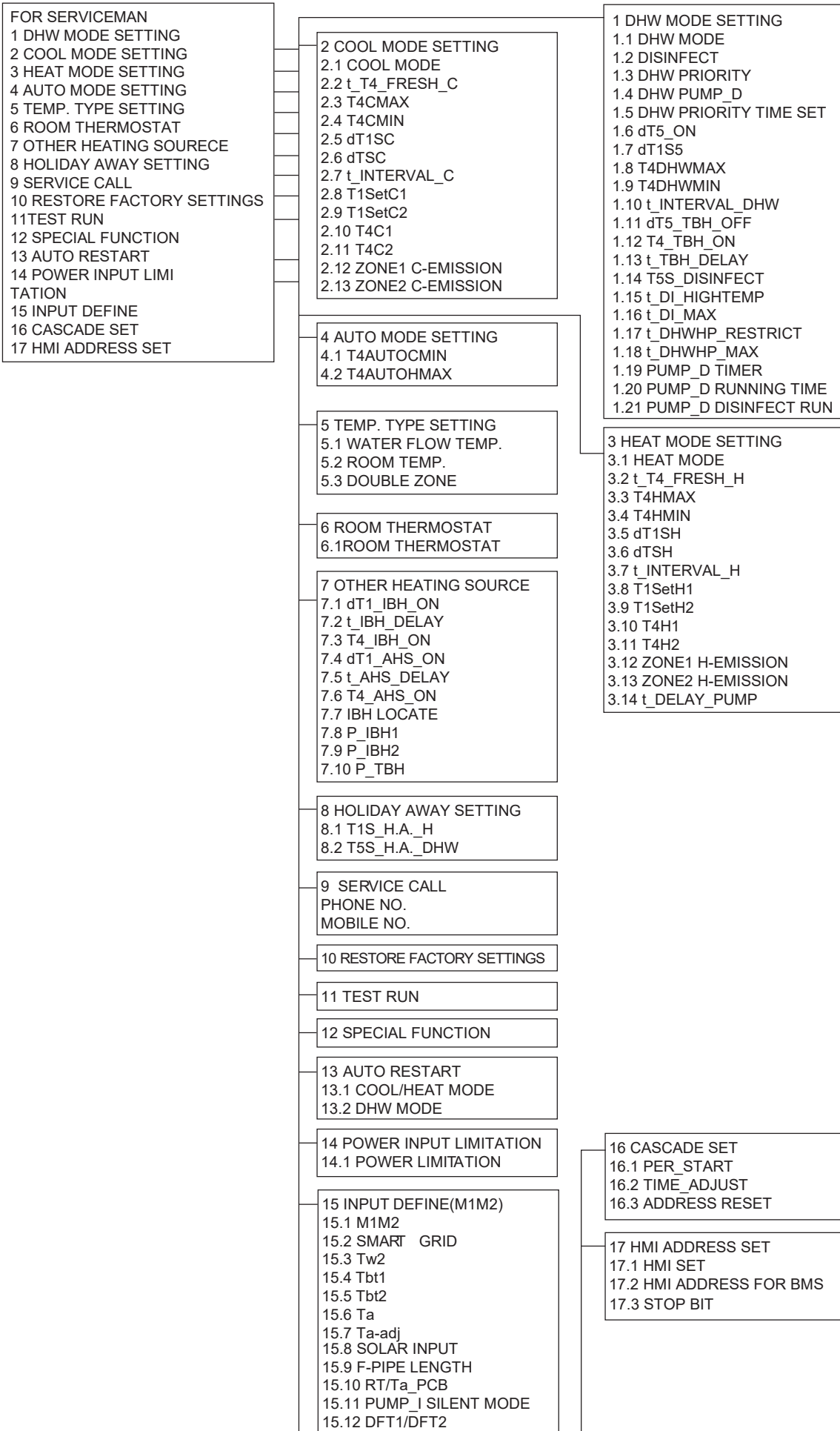

Table 3-7.1: User interface keys

Keys	Function
☰	Go to the menu structure(on the home page)
▲	Navigate the cursor on the display
◀ ▶	Navigate in the menu structure
▼	Adjust settings
⏻	Turn on/off the space heating/cooling operation or DHW mode Turn on/off functions in the menu structure
↶	Come back to the up level
🔒	Long press for unlock/lock the controller Unlock /lock some functions such as “DHW temperature adjusting”
↵	Go to the next step when programming a schedule in the menu structure and confirm a selection to enter in the submenu of the menu structure.

7.2 Menu Structure



7.3 FOR SERVICEMAN Menu

FOR SERVICEMAN allows installers to input the system configuration and set the system parameters. To enter **FOR SERVICEMAN**, go to **MENU > FOR SERVICEMAN**.

Enter the password, using ◀ ▶ to navigate between digits and using ▼ ▲ to adjust the numerical values, and then press **OK**. The password is 234. Refer to Figure 3-7.2

Then the following pages will be displayed after putting the password. Refer to Figure 3-7.3

Figure 3-7.2: FOR SERVICEMAN password screen

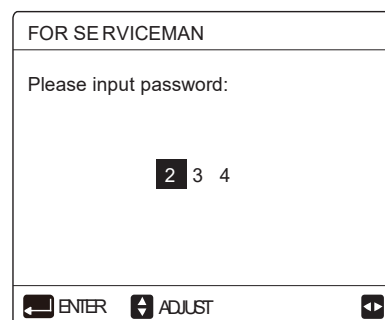

Figure 3-7.3: FOR SERVICEMAN menu

FOR SERVICEMAN 1/3	FOR SERVICEMAN 2/3	FOR SERVICEMAN 3/3
1. DHW MODE SETTING	7. OTHER HEATING SOURCE	13. AUTO RESTART
2. COOL MODE SETTING	8. HOLIDAY AWAY SETTING	14. POWER INPUT LIMITATION
3. HEAT MODE SETTING	9. SERVICE CALL SETTING	15. INPUT DEFINE
4. AUTO MODE SETTING	10. RESTORE FACTORY SETTINGS	16. CASCADE SET
5. TEMP.TYPE SETTING	11. TEST RUN	17. HMI ADDRESS SET
6. ROOM THERMOSTAT	12. SPECIAL FUNCTION	
ENTER ADJUST	ENTER ADJUST	ENTER ADJUST

7.4 DHW MODE SETTING Menu

7.4.1 DHW MODE SETTING menu overview

MENU > FOR SERVICEMAN > DHW MODE SETTING

Figure 3-7.4: DHW MODE SETTING menu

1 DHW MODE SETTING 1/5	1 DHW MODE SETTING 2/5	1 DHW MODE SETTING 3/5
1.1 DHW MODE YES	1.6 dT5_ON 5 °C	1.11 dT5_TBH_OFF 5 °C
1.2 DISINFECT YES	1.7 dT1S5 10 °C	1.12 T4_TBH_ON 5 °C
1.3 DHW PRIORITY YES	1.8 T4DHWMAX 43 °C	1.13 t_TBH_DELAY 30 MIN
1.4 DHW PUMP_D YES	1.9 T4DHWMIN -10 °C	1.14 T5S_DISINFECT 65 °C
1.5 DHW PRIORITY TIME SET NON	1.10 t_INTERVAL_DHW 5 MIN	1.15 t_DI_HIGHTEMP. 15MIN
ADJUST	ADJUST	ADJUST
1 DHW MODE SETTING 4/5	1 DHW MODE SETTING 5/5	
1.16 t_DI_MAX 210 MIN	1.21 PUMP_D DISINFECT RUN NON	
1.17 t_DHWHP_RESTRICT 30 MIN		
1.18 t_DHWHP_MAX 120 MIN		
1.19 PUMP_D TIMER YES		
1.20 PUMP_D RUNNING TIME 5 MIN		
ADJUST	ADJUST	

In **DHW MODE SETTING** the following parameters should be set.

DHW MODE enables or disables DHW mode. For installations with DHW tanks, select **YES** to enable DHW mode. For installations without DHW tanks, select **NON** to disable DHW mode.

DISINFECT sets whether or not the disinfection operation is performed.

DHW PRIORITY sets whether domestic hot water heating or space heating/cooling takes priority. If **NON** is selected in the **DHW PRIORITY** mode, when it is available and the space heating/cooling is **OFF**, the heat pump will heat the water as required. If space heating/cooling is **ON**, the water will be heated as required when the immersion heater is unavailable.

Mono

Only when the space heating/cooling is **OFF** will the heat pump operate to heat domestic water.

DHW PUMP sets whether or not the DHW pump is controlled by the Mono unit. If the DHW pump is to be controlled by the Mono, select **YES**. If the DHW pump is not to be controlled by the Mono unit, select **NON**.

DHW PUMP PRIORITY TIME SET set the operation time of DHW during **DHW PRIORITY** mode.

dT5_ON sets the temperature difference between the DHW set temperature (T5S) and the DHW tank water temperature (T5) above which the heat pump providing heated water to the DHW tank. When $T5S - T5 \geq dT5_ON$ the heat pump providing heated water to the DHW tank.

Note: When the heat pump's leaving water temperature is above the DHW mode leaving water temperature operating limit (T5stop), the heat pump does not provide heated water to the DHW tank. The DHW mode leaving water temperature operating limit is related to ambient temperature as shown in Figure 2-6.3 in Part 2, 6 "Operating Limits".

dT1S5 sets the heat pump's leaving water set temperature (T1S) relative to DHW tank water temperature (T5). For DHW mode, the user sets the DHW set temperature (T5S) on the main screen and cannot manually set T1S. T1S is set as $T1S = T5 + dT1S5$.

Figure 3-7.6 illustrates the operation of the heat pump and immersion heater(optional) in DHW mode. If the DHW tank water temperature (T5) is less than the minimum of the DHW set temperature (T5S) and the heat pump leaving water temperature operating limit (T5stop) (refer to Figure 2-6.3 in Part 2, 6 "Operating Limits") less **dT5_ON**, the heat pump starts providing heated water to the DHW tank. After **t_TBH_delay** minutes have elapsed, the immersion heater is turned on. If T5 reaches T5stop, the heat pump stops but the immersion heater continues running until T5 has reached $T5S + dT5_TBH_OFF$

T4DHWMAX sets the ambient temperature above which the heat pump will not operate in DHW mode. The highest value that **T4DHWMAX** can take is 43°C, which is the DHW mode upper ambient temperature operating limit of the heat pump.

T4DHWMIN sets the ambient temperature below which the heat pump will not operate in DHW mode. The lowest value that **T4DHWMIN** can take is -25°C, which is the DHW mode lower ambient temperature operating limit of the heat pump.

Figure 3-7.5: dT5_ON

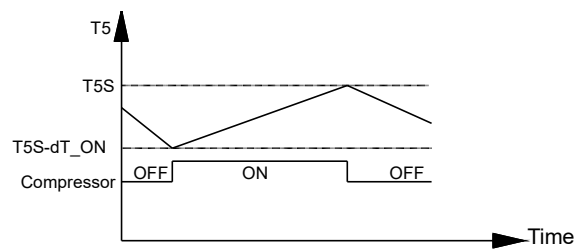

Abbreviations:
T5: DHW tank water temperature
T5S: DHW set temperature

Figure 3-7.6: DHW mode operation

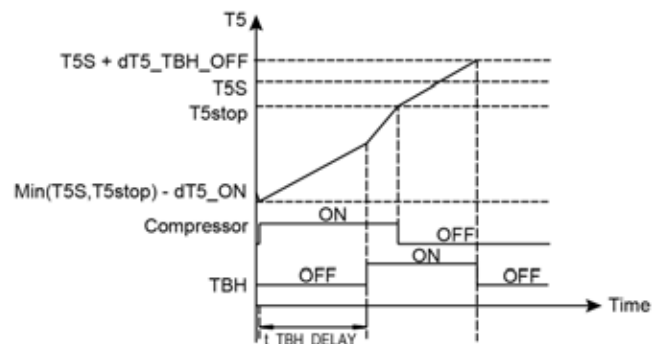

Abbreviations:
T5: DHW tank water temperature
T5S: DHW set temperature
T5stop: DHW mode leaving water temperature operating limit
TBH: Immersion heater in DHW tank

Figure 3-7.7: T4DHWMAX and T4DHWMIN



Abbreviations:
HP: Heat pump
TBH: DWH tank immersion heater
AHS: Additional heating source

t_INTERVAL_DHW sets the DHW mode compressor re-start delay. When the compressor stops running, it will not re-start until at least **t_INTERVAL_DHW** minutes have elapsed.

dT5_TBH_OFF sets the temperature difference between the DHW set temperature (T5S) and the DHW tank water temperature (T5) below which the immersion is not used. When $T5 \geq \text{Min}(T5S + dT5_TBH_OFF, 65^\circ\text{C})$, the immersion heater is off.

T4_TBH_ON sets the ambient temperature above which the immersion heater will not be used.

t_TBH_DELAY sets the delay between the compressor starting and the immersion heater being turned on.

T5S_DISINFECT sets the DHW tank disinfection operation target temperature. Caution: during the disinfection operation (duration: **t_DI_MAX**) the domestic hot water temperature at the hot water taps will at times be equal to the value set for **T5S_DI**.

t_DI_HIGHTEMP sets that length of time that the DHW tank disinfection operation target temperature is maintained.

t_DI_MAX sets the total duration of the DHW tank disinfect operation.

t_DHWHP_RESTRICT sets the maximum length of time that the heat pump will run in space heating or space cooling modes before switching to DHW mode, if a requirement for DHW mode exists. When running in space heating mode or space cooling mode, the heat pump becomes available for DHW mode either as soon as the space heating/cooling set temperatures have been reached (refer to Part 3, 7.5 "COOL MODE SETTING Menu" and Part 3, 7.6 "HEAT MODE SETTING Menu") or after **t_DHWHP_MAX** minutes have elapsed.

t_DHWHP_MAX sets the maximum length of time that the heat pump will run in DWH mode before switching to space heating mode or space cooling mode if a requirement for space heating/cooling modes exists. When running in DHW mode, the heat pump becomes available for space heating/cooling either as soon as the DHW tank water temperature (T5) reaches the DHW set temperature (T5S) or after **t_DHWHP_MAX** minutes have elapsed.

Figure 3-7.8: DHW tank disinfection

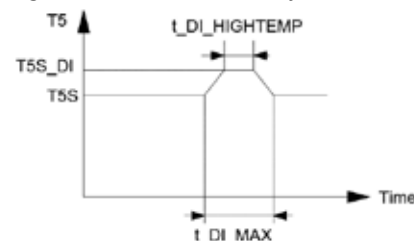

Abbreviations:
 T5: DHW tank water temperature
 T5S: DHW set temperature

Figure 3-7.9 illustrates the effects of **t_DHWHP_MAX** and **t_DHWHP_RESTRICT** when **DHW PRIORITY** is enabled. The heat pump initially runs in DWH mode. After **t_DHWHP_MAX** minutes, T5 has not reached

Figure 3-7.9: Operation in DHW PRIORITY

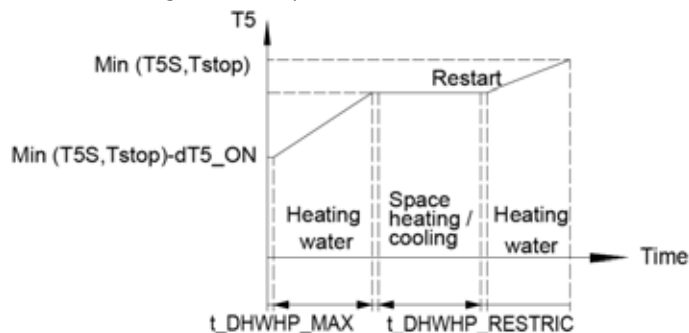

Abbreviations:
 T5: DHW tank water temperature
 T5S: DHW set temperature
 T5stop: DHW mode leaving water temperature operating limit

Mono

PUMP_D TIMER sets whether or not the user is able to set the DHW pump (field supply) in DHW mode. For installations with a DHW pump, select ON so that the user is able to set pump start times.

PUMP_D RUNNING TIME sets the length of time the pump runs for at each of the user-specified start times on the **DHW PUMP** tab on the **DOMESTIC HOT WATER (DHW)** menu, if **TIMER RUNNING** is enabled.

PUMP_D DISINFECT RUN sets whether or not the DHW pump (field supply) operates during the disinfection mode.

7.5 COOL MODE SETTING Menu

MENU > FOR SERVICEMAN > COOL MODE SETTING

Figure 3-7.10: COOL MODE SETTING menu

2 COOL MODE SETTING	1/3	2 COOL MODE SETTING	2/3	2 COOL MODE SETTING	3/3
2.1 COOL MODE	YES	2.6 dTSC	2°C	2.11 T4C2	25°C
2.2 t_T4_FRESH_C	2.0HRS	2.7 t_INTERVAL_C	5MIN	2.12 ZONE1 C-EMISSION	FCU
2.3 T4CMAX	43°C	2.8 T1SetC1	10°C	2.13 ZONE2 C-EMISSION	FLH
2.4 T4CMIN	20°C	2.9 T1SetC2	16°C		
2.5 dT1SC	5°C	2.10 T4C1	35°C		
ADJUST		ADJUST		ADJUST	

In **COOL MODE SETTING** the following parameters should be set.

COOL MODE enables or disables cooling mode. For installations with space cooling terminals, select **YES** to enable cooling mode. For installations without space cooling terminals, select **NON** to disable cooling mode.

t_T4_FRESH_C sets the refresh time of cooling model climate temperature curve.

T4CMAX sets the ambient temperature above which the heat pump will operate in cooling mode with lowest compressor frequency. The highest value that **T4CMAX** can take is 46°C, which is the cooling mode upper ambient temperature operating limit of the heat pump. Refer to Figure 3-7.11.

Figure 3-7.11: T4CMAX, T4CMIN

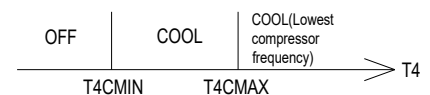

Abbreviations:
T4: Outdoor ambient temperature

T4CMIN sets the ambient temperature below which the heat pump will not operate in cooling mode. The lowest value that **T4CMIN** can take is -5°C, which is the cooling mode lower ambient temperature operating limit of the heat pump. Refer to Figure 3-7.11.

dT1SC sets the minimum temperature difference between the heat pump leaving water temperature (T1) and the heat pump leaving water set temperature (T1S) at which the heat pump provides chilled water to the space cooling terminals. When $T1 - T1S \geq dT1SC$ the heat pump provides chilled water to the space cooling terminals and when $T1 \leq T1S$ the heat pump does not provide chilled water to the space cooling terminals.

Figure 3-7.12: dT1SC

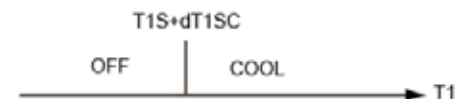

Abbreviations:
T1: Heat pump leaving water temperature
T1S: Heat pump leaving water set temperature

dTSC sets the temperature difference between the actual room temperature (Ta) and set room temperature (TS) above which the heat pump provides chilled water to the space cooling terminals. When $Ta - TS \geq dTSC$ the heat pump provides chilled water to the space cooling terminals and when $Ta \leq TS$ the heat pump does not provide chilled water to the space cooling terminals. Refer to Figure 3-7.13. **dTSC** is only applicable if **YES** is selected for **ROOM TEMP** in the **TEMP. TYPE SETTING** menu. Refer to Part 3,

Figure 3-7.13: dTSC

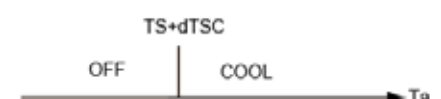

7.8 "TEMP. TYPE SETTING Menu".

t_INTERVAL_C sets the cooling mode compressor re-start delay. When the compressor stops running, it will not re-start until at least **t_INTERVAL_C** minutes have elapsed.

T1SetC1 sets the temperature 1 of automatic setting curve for cooling mode.

T1SetC2 sets the temperature 2 of automatic setting curve for cooling mode.

T4C1 sets the ambient temperature 1 of automatic setting curve for cooling mode.

T4C2 sets the ambient temperature 2 of automatic setting curve for cooling mode.

ZONE1 C-EMISSION sets the emission type of zone1 for cooling mode.

ZONE2 C-EMISSION sets the emission type of zone2 for cooling mode.

7.6 HEAT MODE SETTING Menu

MENU > FOR SERVICEMAN > HEAT MODE SETTING

Figure 3-7.14: HEAT MODE SETTING menu

3 HEAT MODE SETTING	1/3	3 HEAT MODE SETTING	2/3	3 HEAT MODE SETTING	3/3
3.1 HEAT MODE	YES	3.6 dTSH	2°C	3.11 T4H2	7°C
3.2 t_T4_FRESH_H	2.0HRS	3.7 t_INTERVAL_H	5MIN	3.12 ZONE1 H-EMISSION	RAD.
3.3 T4HMAX	16°C	3.8 T1SetH1	35°C	3.13 ZONE2 H-EMISSION	FLH
3.4 T4HMIN	-15°C	3.9 T1SetH2	28°C	3.14 t_DELAY_PUMP	2MIN
3.5 dT1SH	5°C	3.10 T4H1	-5°C		
ADJUST		ADJUST		ADJUST	

In **HEAT MODE SETTING** the following parameters should be set.

HEAT MODE enables or disables heating mode.

t_T4_FRESH_H sets the refresh time of heating model climate temperature curve.

T4HMAX sets the ambient temperature above which the heat pump will operate heating mode with lowest compressor frequency. The highest value that **T4HMAX** can take is 35°C, which is the heating mode upper ambient temperature operating limit of the heat pump. Refer to Figure 3-7.15.

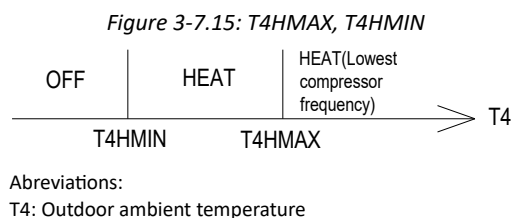

T4HMIN sets the ambient temperature below which the heat pump will not operate in heating mode. The lowest value that **T4HMIN** can take is -25°C, which is the heating mode lower ambient temperature operating limit of the heat pump. Refer to Figure 3-7.15.

Mono

dT1SH sets the temperature difference between the heat pump leaving water temperature (T1) and the heat pump leaving water set temperature (T1S) above which the heat pump provides heated water to the space heating terminals.

Figure 3-7.16: dTSH



Note:
Only when ROOM TEMP is enabled will this function be available

dTSH sets the temperature difference between the actual room temperature (Ta) and set room temperature (TS) above which the heat pump provides heated water to the space heating terminals. When $TS - Ta \geq dTSH$ the heat pump provides heated water to the space heating terminals and when $Ta \geq TS$ the heat pump does not provide heated water to the space heating terminals. Refer to Figure 3-7.16. **dTSH** is only relevant if **YES** is selected for **ROOM TEMP** in the **TEMP. TYPE SETTING** menu. Refer to Part 3, 7.8 “TEMP. TYPE SETTING Menu”.

t_INTERVAL_H sets the heating mode compressor re-start delay. When the compressor stops running, it will not re-start until at least **t_INTERVAL_H** minutes have elapsed.

T1SetH1 sets the temperature 1 of automatic setting curve for heating mode.

T1SetH2 sets the temperature 2 of automatic setting curve for heating mode.

T4H1 sets the ambient temperature 1 of automatic setting curve for heating mode.

T4H2 sets the ambient temperature 2 of automatic setting curve for heating mode.

ZONE1 H-EMISSION sets the emission type for heating mode.

ZONE2 H-EMISSION sets the emission type for heating mode.

7.7 AUTO MODE SETTING Menu

MENU > FOR SERVICEMAN > AUTO MODE SETTING

In **AUTO MODE SETTING** the following parameters should be set.

T4AUTOCMIN sets the ambient temperature below which the heat pump will not provide chilled water for space cooling in auto mode. Refer to Figure 3-7.18.

T4AUTOHMAX sets the ambient temperature above which the heat pump will not provide heated water for space heating in auto mode. Refer to Figure 3-7.18.

Figure 3-7.17: AUTO MODE SETTING menu

4 AUTO. MODE SETTING	
4.1 T4AUTOCMIN	25°C
4.2 T4AUTOHMAX	17°C
↔ ADJUST	↔

Figure 3-7.18: T4AUTOCMAX, T4AUTOCMIN

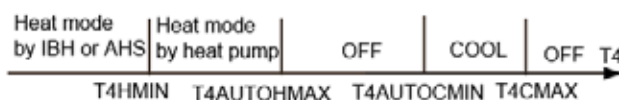

Abbreviations:
 HP: Heat pump
 AHS: Additional heating source
 IBH: Backup electric heater
 T4CMAX: The ambient temperature above which the heat pump will not operate in cooling mode.
 T4HMIN: The ambient temperature below which the heat pump will not operate in heating mode.

7.8 TEMP. TYPE SETTING Menu

MENU > FOR SERVICEMAN > TEMP. TYPE SETTING

The TEMP. TYPE SETTING is used for selecting whether the water flow temperature or room temperature is used to control the ON/OFF of the heat pump.

When ROOM TEMP. is enabled, the target water flow temperature will be calculated from climate-related curves (refer to “9 Climate related curves”).

For installations without room thermostats, space heating and cooling modes can be controlled in one of two different ways:

- according to the Mono leaving water temperature alone
- according to the room temperature detected by the Mono user interface’s built-in temperature sensor alone

WATER FLOW TEMP. sets whether space heating/cooling modes are controlled according to the heat pump leaving water temperature. If **YES** is selected, the user is able to set the heat pump’s leaving water temperature set temperature on the user interface’s main screen.

ROOM TEMP. sets whether space heating/cooling modes are controlled according to the room temperature detected by the temperature sensor in the heat pump user interface. If **YES** is selected, the user is able to set the room temperature set temperature on the user interface’s main screen, no matter what is the setting of **WATER FLOW TEMP.**

DOUBLE ZONE sets whether there are two zones.

If set WATER FLOW TEMP. and ROOM TEMP. to YES, meanwhile set DOUBLE ZONE to NON or YES, the following pages will be displayed. In this case, the setting value of zone 1 is T1S, the setting value of zone 2 is TS(The corresponding TIS2 is calculated according to the climate related curves.)

Figure 3-7.22: DOUBLE ZONE to NON or YES

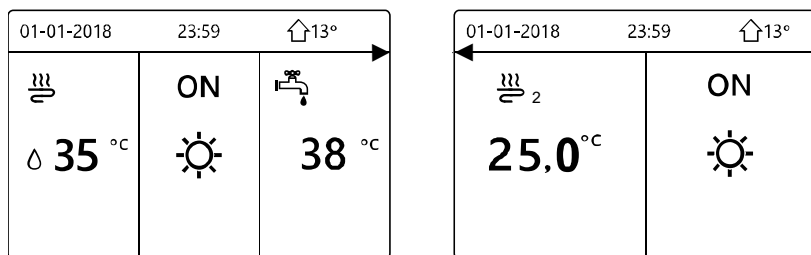

Homepage (zone 1)

Addition page (zone 2)
(Double zone is effective)

If set DOUBLE ZONE to YES and set ROOM TEMP. to NON, meanwhile set WATER FLOW TEMP. to YES or NON, the following pages will be displayed. In this case, the setting value of zone 1 is T1S, the setting value of zone 2 is T1S2.

Figure 3-7.19: TEMP. TYPE SETTING menu

5 TEMP. TYPE SETTING	
5.1 WATER FLOW TEMP.	YES
5.2 ROOM TEMP.	NON
5.3 DOUBLE ZONE	NON
⬇️ ADJUST	⬆️

Figure 3-7.20: Only set WATER FLOW TEMP to YES

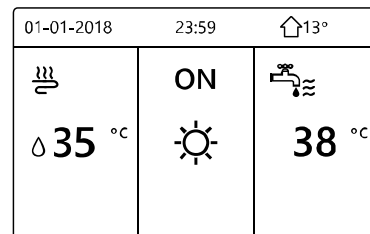
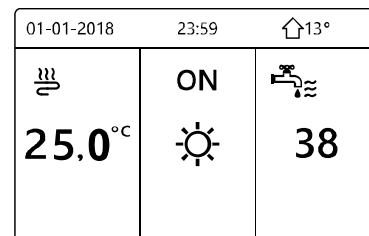

Figure 3-7.21: Only set ROOM TEMP to YES



7.10 OTHER HEATING SOURCE Menu

7.10.1 OTHER HEATING SOURCE menu overview

MENU > FOR SERVICEMAN > OTHER HEATING SOURCE

Figure 3-7.26: OTHER HEATING SOURCE menu

7 OTHER HEATING SOURCE 1/2		7 OTHER HEATING SOURCE 2/2	
7.1 dT1_IBH_ON	5°C	7.6 T4_AHS_ON	5°C
7.2 t_IBH_DELAY	30MIN	7.7 IBH LOCATE	PIPE LOOP
7.3 T4_IBH_ON	-5°C	7.8 P_IBH1	0.0kW
7.4 dT1_AHS_ON	5°C	7.9 P_IBH2	0.0kW
7.5 t_AHS_DELAY	30MIN	7.10 P_TBH	2.0kW
ADJUST		ADJUST	

In **OTHER HEATING SOURCE** the following parameters should be set. Backup electric heater is optional.

dT1_IBH_ON sets the temperature difference between the heat pump’s leaving water set temperature (T1S) and the heat pump’s leaving water temperature (T1) above which the backup electric heater heating element(s) are on. When $T1S - T1 \geq dT1_IBH_ON$ the backup electric heater is on (on models where the backup electric heater has a simple on/off control function).

t_IBH_DELAY sets the delay between the compressor starting and the backup electric heater being turned on.

T4_IBH_ON sets the ambient temperature below which the backup electric heater is used. If the ambient temperature is above **T4_IBH_ON**, the backup electric heater is not used. The relationship between operation of the backup heater and the ambient is shown in Figure 3-7.22.

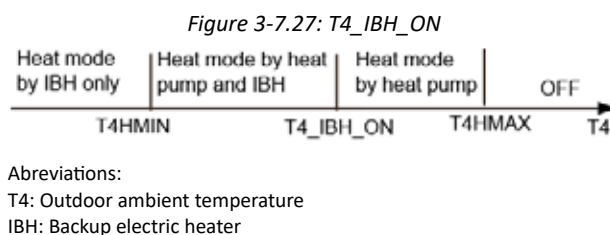

dT1_ASH_ON sets the temperature difference between the heat pump’s leaving water set temperature (T1S) and the heat pump’s leaving water temperature (T1) above which the additional heating source is on. When $T1S - T1 \geq dT1_ASH_ON$ the additional heating source is on.

t_ASH_DELAY sets the delay between the compressor starting and the additional heating source being turned on.

T4_AHS_ON sets the ambient temperature below which the additional heating source is used. If the ambient temperature is above **T4_AHS_ON**, the additional heating source is not used. The relationship between operation of the additional heating source and the ambient is shown in the picture below.

Figure 3-7.28: T4_AHS_ON

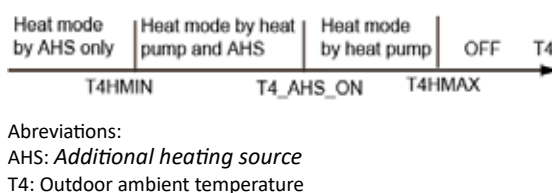

IBH LOCATE means IBH is installed for pipe heating.

P_IBH1, P_IBH2 set heating capacity of IBH and P_TBH sets heating capacity of TBH, which are used for energy consumption statistics.

Mono

7.11 HOLIDAY AWAY SETTING Menu

MENU > FOR SERVICEMAN > HOLIDAY AWAY SETTING

The **HOLIDAY AWAY SETTING** menu settings are used to set the outlet water temperature to prevent water pipes freezing when away from home in cold weather seasons. In **HOLIDAY AWAY SETTING** the following parameters should be set.

T1S_H.A._H sets the heat pump’s leaving water set temperature for space heating mode when in holiday away mode.

T5S_H.M_DHW sets the heat pump’s leaving water set temperature for DHW mode when in holiday away mode.

Figure 3-7.29: HOLIDAY AWAY SETTING menu

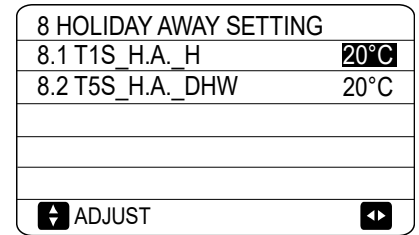

7.12 SERVICE CALL Menu

MENU > FOR SERVICEMAN > SERVICE CALL

In **SERVICE CALL** the following parameters can be set.

PHONE NO. and **MOBILE NO.** can be used to set after-sales service contact numbers. If set, these numbers are displayed to users in **MENU > FOR SERVICEMAN > SERVICE CALL**

Use ▼ ▲ to adjust the numerical values. The maximum length of the phone numbers is 14 digits.

Figure 3-7.30: SERVICE CALL menu

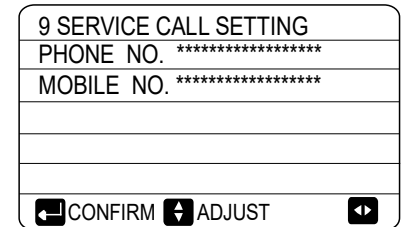

The black rectangle found between 0 and 9 when scrolling up and down using ▼ ▲ is converted to a blank space when the phone numbers are displayed to users in **MENU > FOR SERVICEMAN > SERVICE CALL** and can be used for phone numbers less than 14 digits in length.

7.13 RESTORE FACTORY SETTINGS

MENU > FOR SERVICEMAN > RESTORE FACTORY SETTINGS

RESTORE FACTORY SETTINGS is used to restore all the parameters set in the user interface to their factory defaults.

On selecting **YES**, the process of restoring all settings to their factory defaults begins and progress is displayed as a percentage.

Figure 3-7.31: RESTORE FACTORY SETTINGS screens

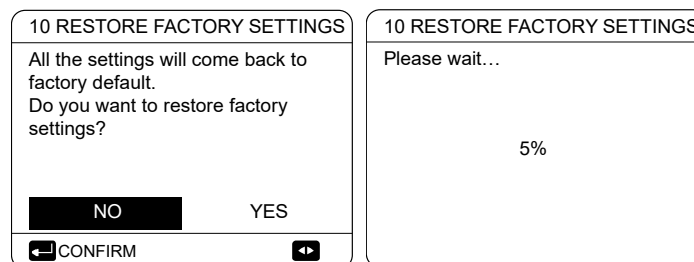

7.14 TEST RUN

7.14.1 TEST RUN Menu overview

MENU > FOR SERVICEMAN > TEST RUN

TEST RUN is used to check that the valves, air purge function, circulation pump, space cooling mode, space heating mode and DHW mode are all operating correctly.

Figure 3-7.32: TEST RUN start screen and TEST RUN menu

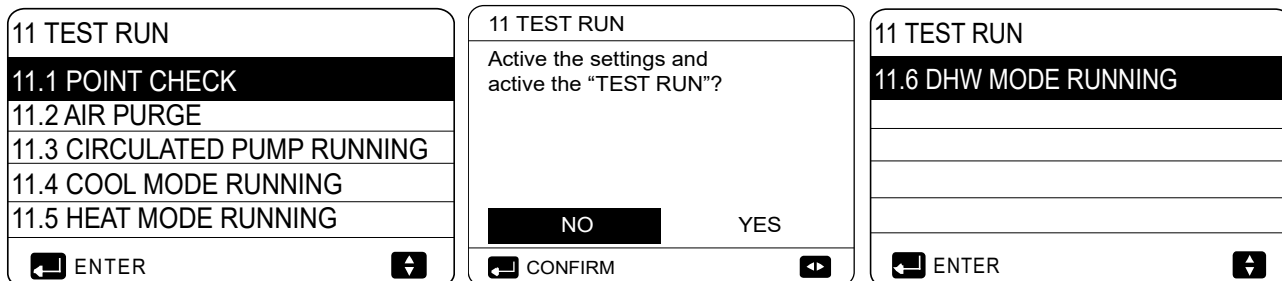

During test run, all buttons except OK are invalid. If you want to turn off the test run, please press OK. For example, when the unit is in air purge mode, after you press OK, the following page will be displayed:

Figure 3-7.33: Exit air purge screen

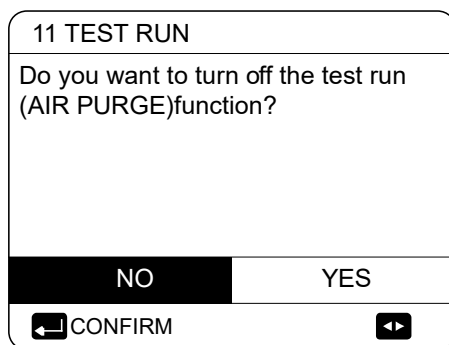

7.14.2 POINT CHECK menu

MENU > FOR SERVICEMAN > TEST RUN > POINT CHECK

The **POINT CHECK** menu is used to check the operation of individual components. Use ▼▲ to scroll to the components you want to check and press ON/OFF to toggle the on/off state of the component. If a valve does not turn on/off when its on/off state is toggled or if a pump/heater does not operate when turned on, check the component’s connection to the hydronic system main PCB.

Figure 3-7.34: POINT CHECK menu

11 TEST RUN	1/2	11 TEST RUN	2/2
3WAY-VALVE 1	OFF	PUMPSOLAR	OFF
3WAY-VALVE 2	OFF	PUMPDHW	OFF
PUMP_I	OFF	INNER BACKUP HEATER	OFF
PUMP_O	OFF	TANK HEATER	OFF
PUMP_C	OFF	3-WAY VALVE 3	OFF
ON/OFF	↕	ON/OFF	↕

Mono

7.14.3 AIR PURGE operation

MENU > FOR SERVICEMAN > TEST RUN > AIR PURGE

Once installation is complete it is important to run the air purge function to remove any air which may be present in the water piping and which could cause malfunctions during operation.

The **AIR PURGE** operation is used to remove air from the water piping. Before running AIR PURGE mode, make sure that the air purge valve is open. When the air purge operation starts, SV1 valve opens and SV2 valve closes. 60 secs later the pump in the unit (PUMPI) operates for 10min during which the flow switch does not work. After the pump stops, SV1 valve closes and SV2 valve opens. 60 secs later both PUMPI and PUMPO operate until the next command is received. If any error code is displayed during the air purge operation, the cause should be investigated. Refer to Part 3, 10 "Error Code table".

Figure 3-7.35: AIR PURGE operation

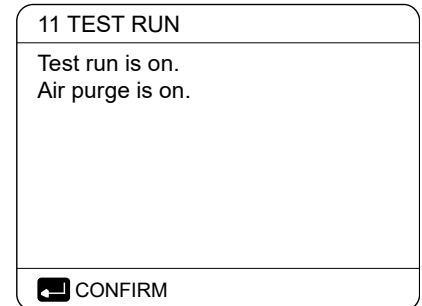

7.14.4 CIRCULATION PUMP RUNNING operation

MENU > FOR SERVICEMAN > TEST RUN > CIRCULATION PUMP RUNNING

The **CIRCULATION PUMP RUNNING** operation is used to check the operation of the circulation pump. When the circulation pump running operation starts, all running components stop. 60 secs later, the 3-way valve opens and the 3-way valve closes. After a further 60 secs PUMPI starts. 30 seconds later, if the flow switch detects that the water flow is normal, PUMPI operates for 3 mins. After the pump stops 60s, the 3-way valve closes and the 3-way valve opens. 60s later both PUMI and PUMPO will operate. After a further 2 mins the flow switch start to check the water flow. If the water flow rate is sufficient, both PUMPI and PUMPO operate until the next command is received. If the water flow rate is insufficient over any 15-second period, PUMPI and PUMPO stop and error code E8 is displayed. Refer to Part 3, 10 "Error Code table".

Figure 3-7.36: CIRCULATION PUMP RUNNING display

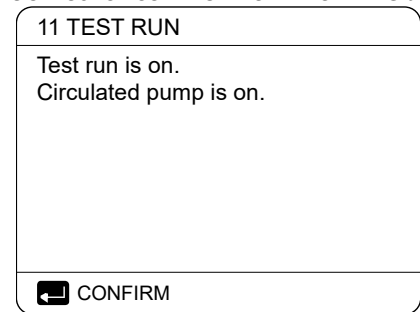

7.14.5 COOL MODE RUNNING operation

MENU > FOR SERVICEMAN > TEST RUN > COOL MODE RUNNING

The **COOL MODE RUNNING** operation is used to check the operation of the system in space cooling mode.

During the **COOL MODE RUNNING** operation, the Mono unit leaving water set temperature is 7°C. The current actual leaving water temperature is displayed on the user interface. The unit operates until the leaving water temperature drops to the set temperature or the next command is received.

Figure 3-7.37: COOL MODE RUNNING display

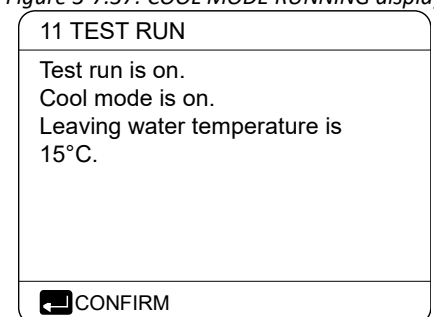

If any error code is displayed during the cool mode running operation, the cause should be investigated. Refer to Part 3, 10 "Error Code table".

7.14.6 HEAT MODE RUNNING operation

The **HEAT MODE RUNNING** operation is used to check the operation of the system in space heating mode.

During the **HEAT MODE RUNNING** operation the Mono unit leaving water set temperature is 35°C. The current actual leaving water temperature is displayed on the user interface. When the **HEAT MODE RUNNING** operation starts, the heat pump first runs for 10 mins.

After 10 mins:

- On systems where an auxiliary heat source (AHS) is installed, the AHS starts and runs for 10 mins (whilst the heat pump continues running), after which the AHS stops and the heat pump continues to operate until the water temperature rises to the set temperature or the heat mode running operation is exited by pressing **OK**.
- On systems where a backup electric heater is being used, the backup heater turn on (on models where the backup heater has a simple on/off control function). 3 mins later the backup electric heater will turn off. The heat pump will then operate until the water temperature rises to the set temperature or the **next command is received**.
- On systems with no auxiliary heat source (AHS), the heat pump will then operate until the water temperature rises to the set temperature or the **next command is received**.

If any error code is displayed during the cool mode running operation, the cause should be investigated. Refer to Part 3, 8.2 "Error Code table".

7.14.7 DHW MODE RUNNING operation

The **DHW MODE RUNNING** operation is used to check the operation of the system in DHW mode.

During the **DHW MODE RUNNING** operation, the DHW set temperature is 55°C. On systems where a tank boost heater is installed, the tank boost heater will turn on once the heat pump has run for 10 mins. The tank boost heater will turn off 3 mins later and the heat pump will operate until the water temperature rises to the set temperature or the **next command is received**.

Figure 3-7.38: HEAT MODE RUNNING display

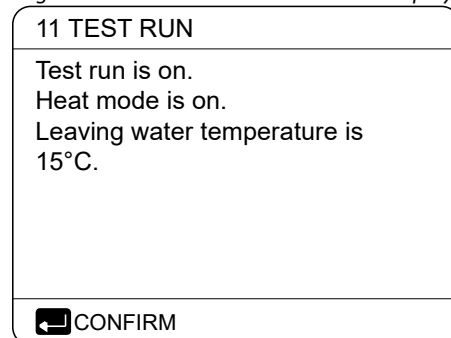
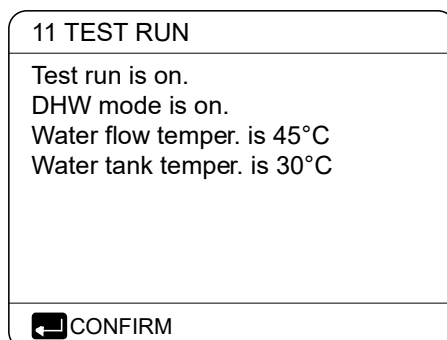

Figure 3-7.39: DHW MODE RUNNING display



Mono

7.15 SPECIAL FUNCTION

7.15.1 SPECIAL FUNCTION menu overview

MENU > FOR SERVICEMAN > SPECIAL FUNCTION

SPECIAL FUNCTION is used to pre-heating floor and drying up floor once installation is complete or the first time start up the unit or restart the unit after a long time stop.

Figure 3-7.40: Special functions menu

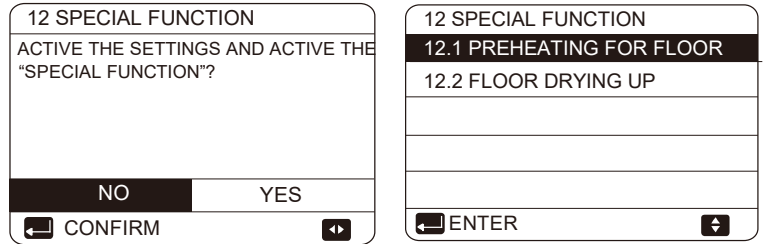

7.15.2 PREHEATING FOR FLOOR

MENU > FOR SERVICEMAN > SPECIAL FUNCTION > PREHEATING FOR FLOOR

Before floor heating, if a large amount of water remains on the floor, the floor may be warped or even rupture during floor heating operation, in order to protect the floor, floor drying is necessary, during which the temperature of the floor should be increased gradually.

During first operation of the unit, air may remain in the water system which can cause malfunctions during operation. It is necessary to run the air purge function to release the air (make sure the air purge valve is open).

T1S sets the heat pump's leaving water set temperature in preheating for floor mode.

t_fristFH sets the duration of preheating for floor mode.

The operation of the unit during preheating for floor mode is illustrated in Figure 3-7.37.

Figure 3-7.41: Preheating for floor menu

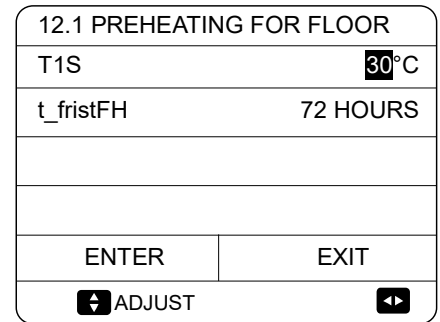
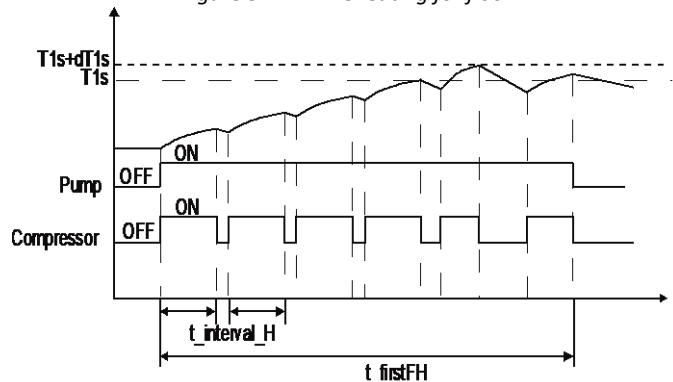

Figure 3-7.42: Preheating for floor



Abbreviations:
 t_interval_H: Compressor re-start delay in space heating mode. (Refer to Part 3, 8.6 "HEAT MODE SETTING Menu").

Whilst the preheating for floor operation is running, the number of minutes that it has been running for and the heat pump's leaving water temperature are displayed on the user interface. During the preheating for floor operation all buttons except **OK** are inactivated. To exit the preheating for floor operation, press **OK** and then select **YES** when prompted. Refer to Figure 3-7.38.

Figure 3-7.43: Preheating for floor screens

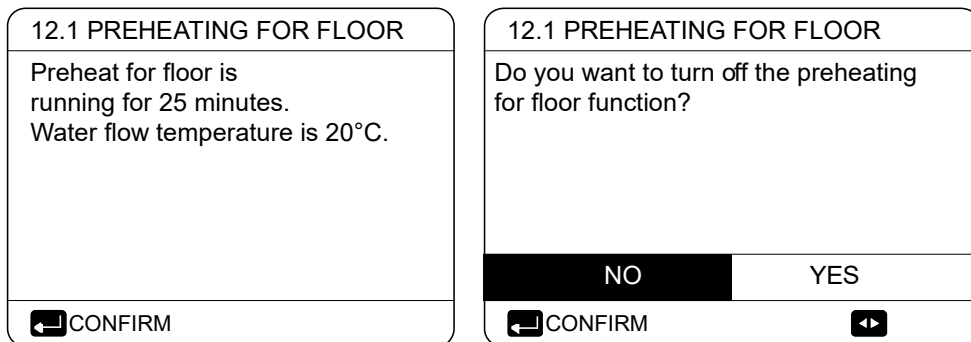

7.15.3 FLOOR DRYING UP

MENU > FOR SERVICEMAN > SPECIAL FUNCTION > FLOOR DRYING UP

Figure 3-7.44: FLOOR DRYING UP menu

12.2 FLOOR DRYING UP	1/2	12.2 FLOOR DRYING UP	2/2
WARM UP TIME(t_DRYUP)	8 days	START DATE	01-01-2019
KEEP TIME(t_HIGHPEAK)	5 days		
TEMP. DOWN TIME(t_DRYDOWN)	5 days		
PEAK TEMP.(T_DRYPEAK)	45°C		
START TIME	15:00	ENTER	EXIT
ADJUST		ADJUST	

For newly-installed under-floor heating systems, floor drying up mode can be used to remove moisture from the floor slab and subfloor to prevent warping or rupture of the floor during floor heating operation. There are three phases to the floor drying up operation:

- Phase 1: gradual temperature increase from a starting point of 25°C to the peak temperature
- Phase 2: maintain peak temperature
- Phase 3: gradual temperature decrease from the peak temperature to 45°C

WARM UP TIME(t_DRYUP) sets the duration of Phase 1.

KEEP TIME(t_HIGHPEAK) sets the duration of Phase 2.

TEMP. DOWN TIME(t_DRYDOWN) is the duration of Phase 3.

PEAK TEMP.(T_DRYPEAK) sets the heat pump’s leaving water set temperature for Phase 2.

START TIME sets the floor drying up operation start time.

START DATE sets the floor drying up operation start date.

Figure 3-7.45: FLOOR DRYING UP settings

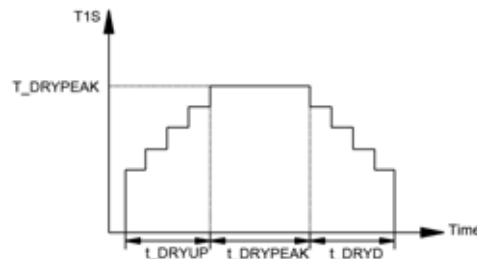

The heat pump’s leaving water set temperature during the floor drying up operation is illustrated in Figure 3-7.40.

During the floor drying up operation all buttons except **OK** are inactivated. To exit the floor drying up operation, press **OK** and then select **YES** when prompted.

Note: In the event of a heat pump malfunction, floor drying up mode will continue if a backup electric heater and/or additional heating source is available and configured to support space heating mode.

Mono

7.16 AUTO RESTART

MENU > FOR SERVICEMAN > AUTO RESTART

AUTO RESTART sets whether or not the unit re-applies the user interface settings when the power returns following a power failure. Select **YES** to enable auto restart or **NON** to disable auto restart.

If the auto restart function is enabled, when the power returns following a power failure, the unit re-applies the user interface settings from before the power failure. If the auto restart function is disabled, when the power returns after a power failure, the unit won't auto restart.

Figure 3-7.47: AUTO RESTART menu

13 AUTO RESTART	
13.1 COOL/HEAT MODE	YES
13.2 DHW MODE	NON
ADJUST	◀▶

7.17 POWER INPUT LIMITATION

MENU > FOR SERVICEMAN > POWER INPUT LIMITATION

POWER INPUT LIMITATION sets the type of power input limitation and the setting range is 0-8. If the unit will operate at larger power input, 0 should be selected. If the unit will operate at a lower power input, 1-8 should be selected and the power input and capacity will decrease.

Figure 3-7.48: POWER INPUT LIMITATION menu

14 POWER INPUT LIMITATION	
14.1 POWER INPUT LIMITATION	0
ADJUST	◀▶

Figure 3-7.49: Limitation value (unit:A)

Model \ No.	0	1	2	3	4	5	6	7	8
22kW	21	21	20	19	18	17	16	15	14
30kW	28	28	27	26	25	24	23	22	21

7.18 INPUT DEFINE

MENU > FOR SERVICEMAN > INPUT DEFINE

Figure 3-7.50: INPUT DEFINE

15 INPUT DEFINE	
15.1 M1M2	REMOTE
15.2 SMART GRID	NON
15.3 Tw2	NON
15.4 Tbt1	NON
15.5 Tbt2	NON
ADJUST	◀▶

15 INPUT DEFINE	
15.6 Ta	HMI
15.7 Ta-adj	-2°C
15.8 SOLAR INPUT	NON
15.9 F-PIPE LENGTH	<10m
15.10 RT/Ta_PCB	NON
ADJUST	◀▶

15 INPUT DEFINE	
15.11 PUMP_1 SILENT MODE	NON
15.12 DFT1/DFT2	DEFROST
ADJUST	◀▶

INPUT DEFINE sets sensors and functions to fulfill with installation.

M1M2 sets the control function of M1M2 for remote ON/OFF of unit or AHS or TBH

SMART GRID sets whether SMART GRID control signal is connected to hydronic PCB.

Tw2 sets whether T1b sensor exist in the installation.

Tbt1 set whether balance tank temperature sensors are installed in the balance tank. (Tbt1 sensor, individually purchase;Tbt2, reserved)

Ta sets the Ta sensor connection type (HMI: Ta on wired controller; IDU: Ta connected on hydronic PCB)

Ta-adj is an correction value for Ta.

SOLAR INPUT sets whether solar control signal is connected to hydronic PCB. (0=NON; 1=CN18; Tsolar 2=CN11SL1SL2)

F-PIPE LENGTH sets the length of refrigerant pipes between outdoor unit and indoor unit.

RT/Ta_PCB sets whether M-kit is valid.

Pump silent mode can decrease water pump maximum output by 5% in order to decrease the noise of heat pump.

DFT1/DFT2 sets DFT1 and DFT2 port of the hydro module as DEFROST or Alarm(ALARM function can be valid only with IDU software version higher than V99)

7.19 CASCADE SET

MENU > FOR SERVICEMAN > CASCADE SET

Figure 3-7.51: CASCADE SET

16 CASCADE SET	
16.1 PER_START	20%
16.2 TIME_ADJUST	5 MIN
16.3 ADDRESS RESET	FF
↕ ADJUST	

PER_START sets the start-up percentage of multiple units for the first time start-up after power on. For example:

Total units	PER_START	Starting units
6	50%	3
6	30%	2

TIME_ADJUST sets the judgment period of adding and subtracting units

ADDRESS RESET resets the address code of unit.("FF" is an invalid address code.) Normally, program will set the address for each unit automatically, only when unit lost address and Hd error code appears then we need to use this function. After setting the address, you need to press the "UNLOCK" key to confirm.

7.20 HMI ADDRESS SET

MENU > FOR SERVICEMAN > HMI ADDRESS SET

Figure 3-7.52: HMI ADDRESS SET

17 HMI ADDRESS SET	
17.1 HMI SET	MASTER
17.2 HMI ADDRESS FOR BMS	1
17.3 STOP BIT	1
↕ ↵	

HMI SET sets the wired controller is master or slave. (0=MASTER, 1=SLAVE)

When HMI SET is set to SLAVE, the controller can only switch the operation mode, turn on or off, set the temperature, and cannot set other parameters and functions.

HMI ADDRESS FOR BMS sets the HMI address code for BMS.(only valid for master controller)

The **STOP BIT** of wired controller and upper computer software should be the same to ensure the reliability of data transformation.

8 Operation parameter

MENU > OPERATION PARAMETER

This menu is for installer or service engineer reviewing the operation parameters. There are nine pages for the operating parameter as following

Figure 3-9.1: Operation parameter

OPERATION PARAMETER #01	OPERATION PARAMETER #01	OPERATION PARAMETER #01
ONLINE UNITS NUMBER 1	PUMP-O OFF	GAS BOILER OFF
OPERATE MODE COOL	PUMP-C OFF	T1 LEAVING WATER TEMP. 35°C
SV1 STATE ON	PUMP-S OFF	WATER FLOW 1.72m ³ /h
SV2 STATE OFF	PUMP-D OFF	HEAT PUMP CAPACTIY 11.52kW
SV3 STATE OFF	PIPE BACKUP HEATER OFF	POWER CONSUM. 1000kWh
PUMP_I ON	TANK BACKUP HEATER ON	Ta ROOM TEMP 25°C
ADDRESS 1/9	ADDRESS 2/9	ADDRESS 3/9

OPERATION PARAMETER #01	OPERATION PARAMETER #01	OPERATION PARAMETER #01
T5 WATER TANK TEMP. 53°C	Tbt1 BUFFERTANK_UP TEMP. 35°C	ODU MODEL 6kW
Tw2 CIRCUIT2 WATER TEMP. 35°C	Tbt2 BUFFERTANK_LOW TEMP. 35°C	COMP.CURRENT 12A
TIS' C1 CLIMATE CURVE TEMP. 35°C	Tsolar 25°C	COMP.FREQUENCY 24Hz
TIS2' C2 CLIMATE CURVE TEMP. 35°C	IDU SOFTWARE 01-09-2019V01	COMP.RUN TIME 54 MIN
TW_O PLATE W-OUTLET TEMP. 35°C		COMP.TOTAL RUN TIME 1000Hrs
TW_I PLATE W-OUTLET TEMP. 30°C		EXPANSION VALVE 200P
ADDRESS 4/9	ADDRESS 5/9	ADDRESS 6/9

OPERATION PARAMETER #01	OPERATION PARAMETER #01	OPERATION PARAMETER #01
FAN SPEED 600R/MIN	TW_O PLATE W-OUTLET TEMP. 35°C	T3 OUTDOOR EXCHANGE TEMP. 5°C
IDU TARGET FREQUENCY 46Hz	TW_I PLATE W-INLET TEMP. 30°C	T4 OUTDOOR AIR TEMP. 5°C
FREQUENCY LIMITED TYPE 5	T2 PLATE F-OUT TEMP. 35°C	TF MODULE TEMP. 55°C
SUPPLY VOLTAGE 230V	T2B PLATE F-IN TEMP. 35°C	P1 COMP. PRESSURE 2300kPa
DC GENERATRIX VOLTAGE 420V	Th COMP. SUCTION TEMP. 5°C	ODU SOFTWARE 01-09-2018V01
DC GENERATRIX CURRENT 18A	Tp COMP. DISCHARGE TEMP. 75°C	HMI SOFTWARE 01-09-2018V01
ADDRESS 7/9	ADDRESS 8/9	ADDRESS 9/9

9 Network Configuration Guidelines

The wired controller realizes intelligent control with a built-in WIFI module, which receives control signal from the APP. Before connecting the WLAN, please check for it if the router in your environment is active and make sure that the wired controller is well-connected to the wireless signal. When the product is connected to the network, please make sure that the phone is as close as possible to the product. KAISAI only supports 2.4GHz band routers at present. Special characters (punctuation, spaces, etc.) are not recommended as part of the WLAN name. It is recommended that you connect no more than 10 devices to a single router lest home appliances are affected by weak or unstable network signal. If the password of the router or WLAN is changed, clear all settings and reset the appliance. APP interface changes from time to time as APP is updated and may change slightly vary from those in this document.

9.1 Install APP

Scan the following QR code or research "Comfort Home" in APP STORE or GOOGLE PLAY to install the APP.



9.2 First run

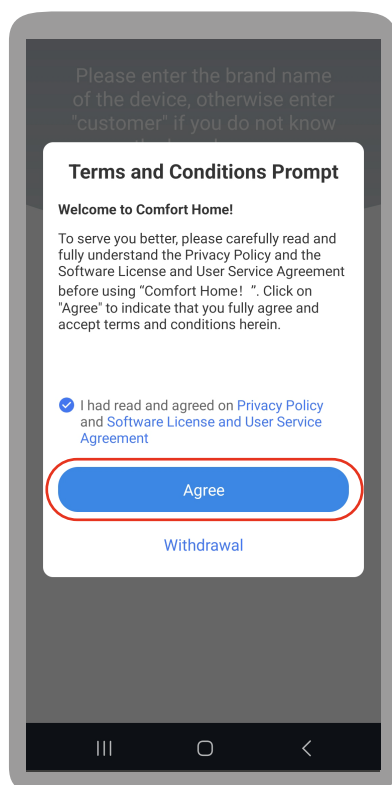

After installation, open the APP and read and accept the privacy policy.

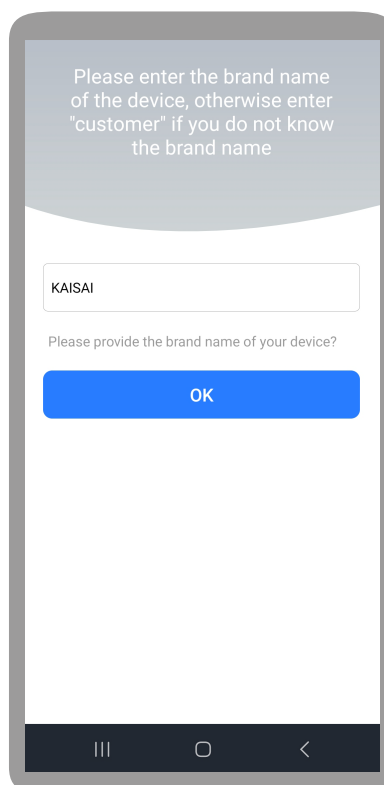

Enter the registration code - „KAISAI“

9.3 Log in or register

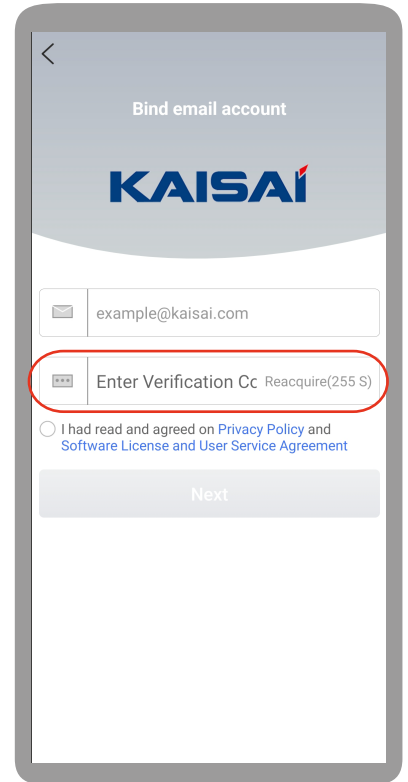
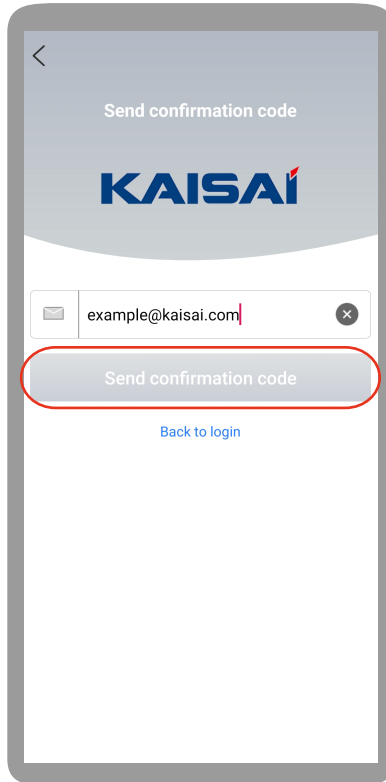
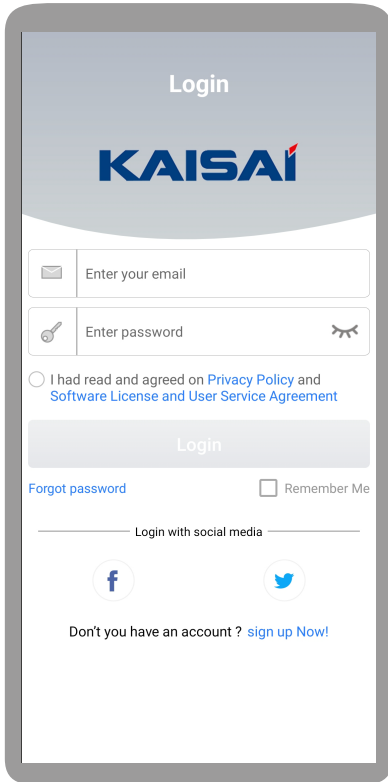

In case of a new user registration it is necessary to enter a verification code sent to the specified e-mail address.

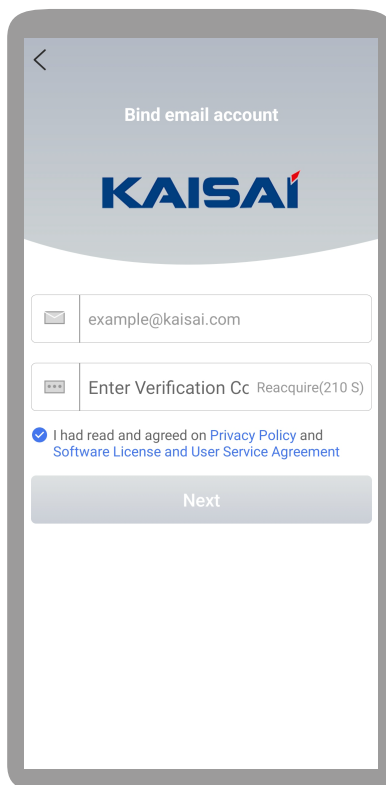

Accept the privacy policy and conditions for using the application

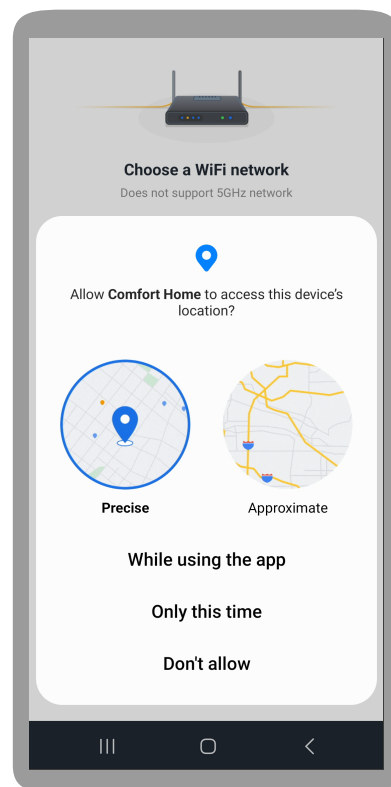
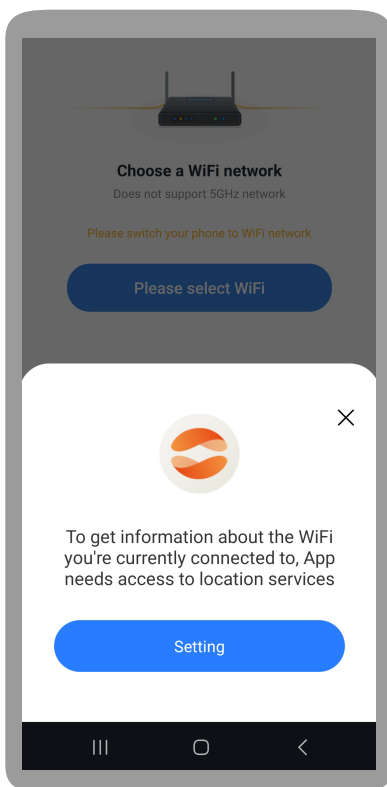
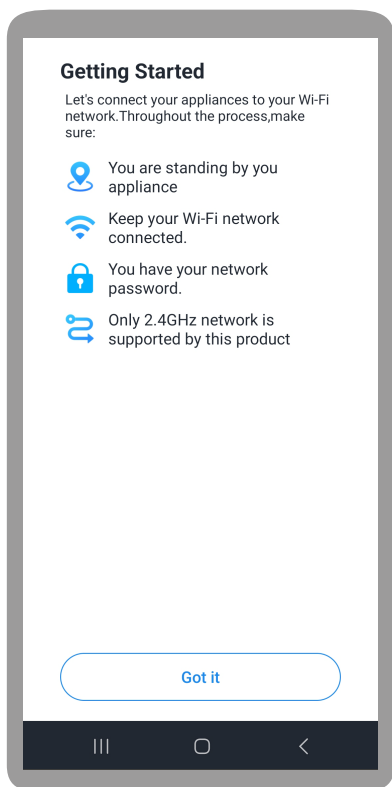

9.4 Wi-Fi connection

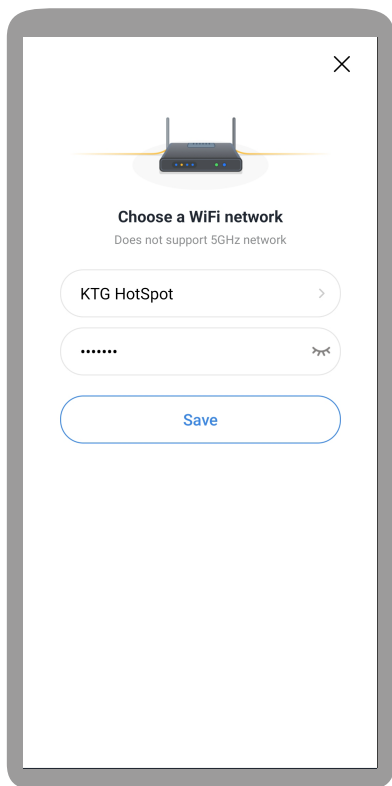

Network name and password may not contain languagespecific or special characters.

9.5 Device management



From the application, you can add new devices or manage existing ones.



9.6 AP mode on the controller

Choose the right arrow on the controller to go to the AP mode.

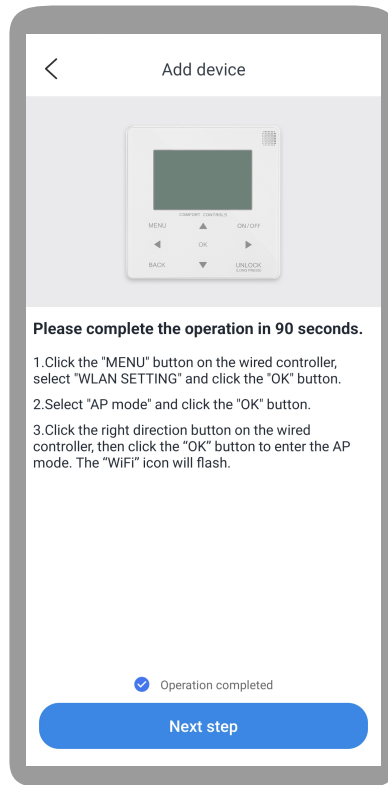

When the Wi-Fi icon starts to flash, move forward.

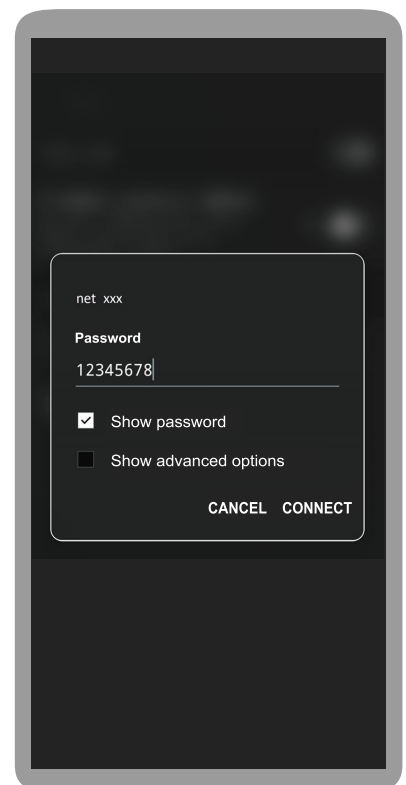
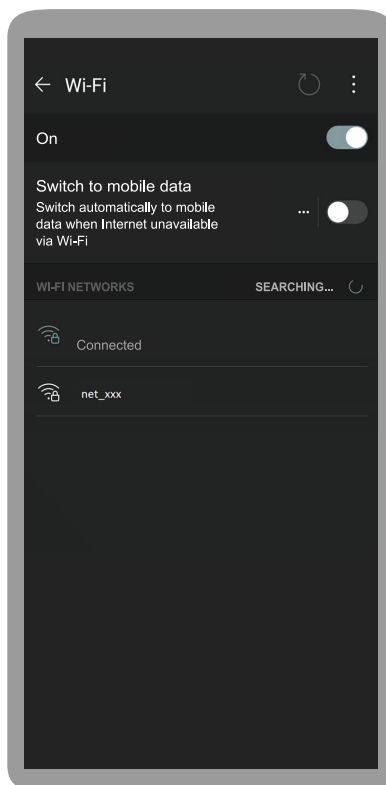
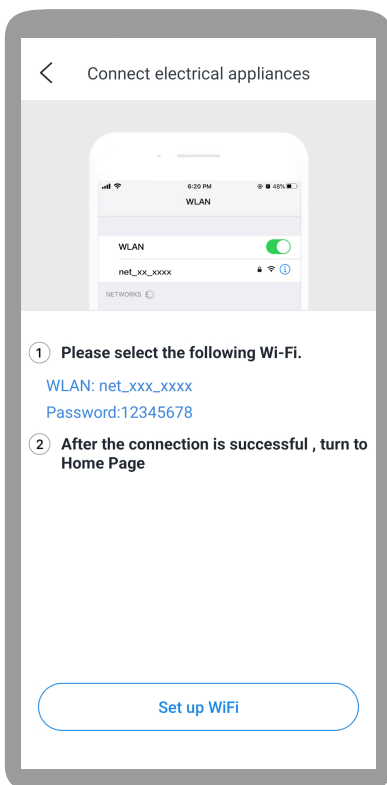

No access to the Internet

Confirm the message displayed on the phone's screen by choosing OK.

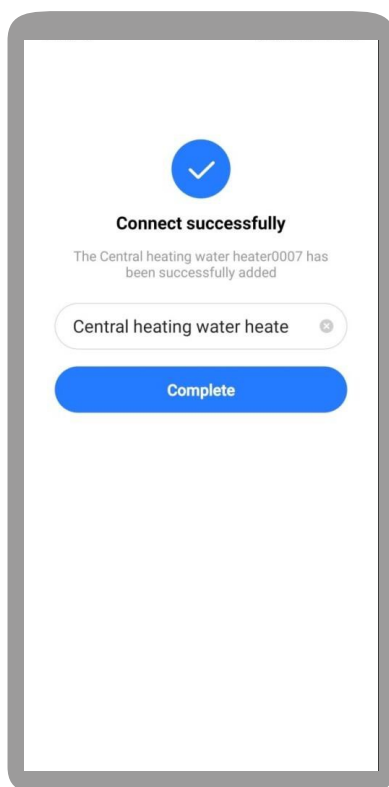
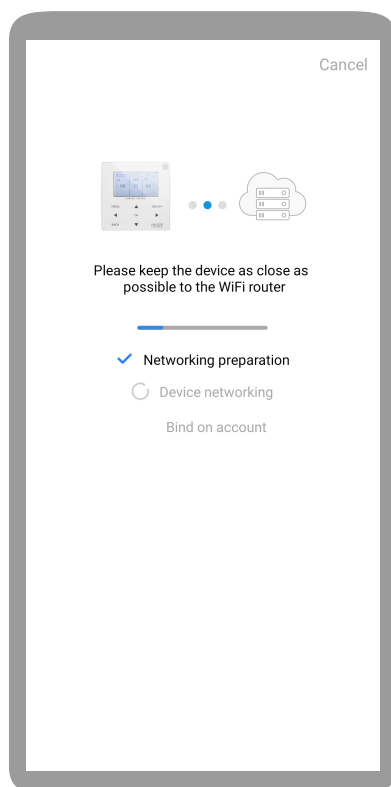
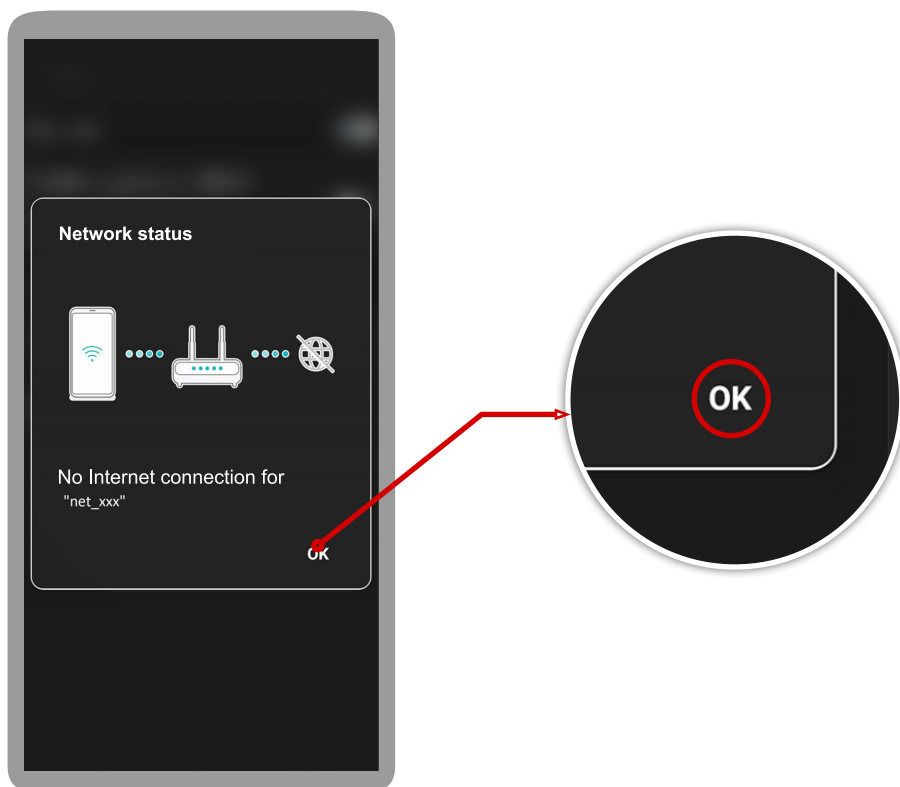

10 USB function guidelines

10.1 Parameters setting transfer between wired controllers

Installer can quickly copy the wired controller parameter settings from unit A to unit B via USB disk, which save the time of on-site installation. Steps are as follows:

Step 1:

Plug U disk into the port of hydronic PCB of A unit.

“USB” appears on digital display

Wired controller interface automatically changes

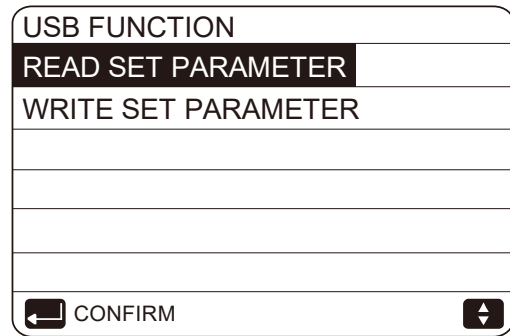
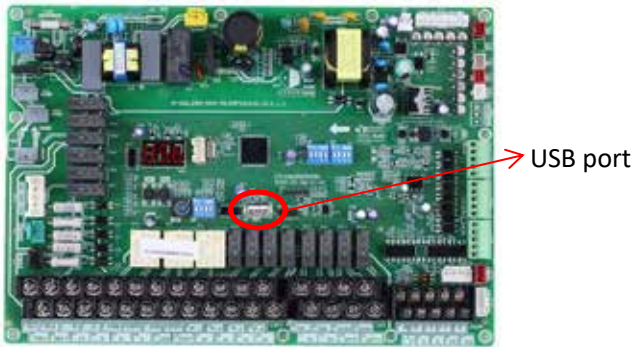

Step 2:

Select “READ SET PARAMETER” and press “OK” button then rate of progress will appear. When the process is finished, “SUCCESS” appears below and an EXCEL file which can not be seen in the wired controller interface but users can find it on computer will be generated inside the USB disk.

Select “READ SET PARAMETER”

Finished

EXCEL generated

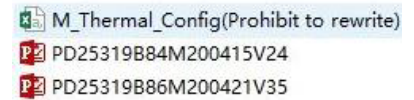
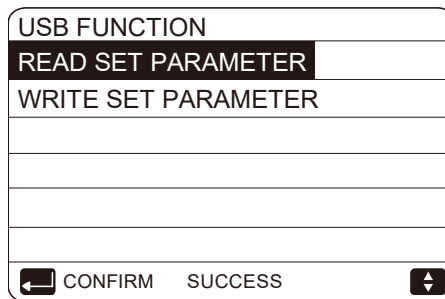
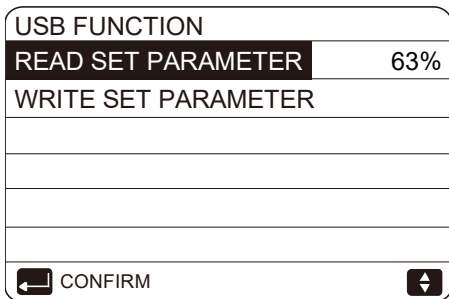

After that, if parameter correction is needed, please connect the USB with computer and open the EXCEL file to change parameters and then save it. Please do not change the file name or format. Parameters are not allowed for non-professionals to change and Midea recommends to use the wired controller to change the parameters.

Step 3:

Plug USB disk into the port of hydronic PCB of B unit and select “WRITE SET PARAMETER” then rate of progress will appear. When the process is finished, “SUCCESS” appears below.

Select “WRITE SET PARAMETER”

Finished

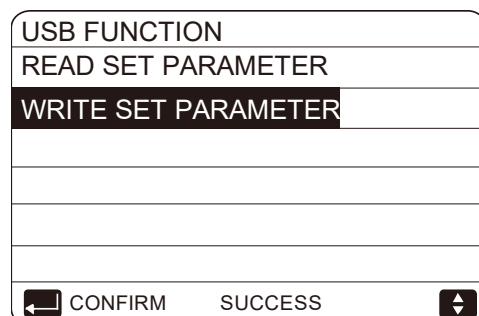
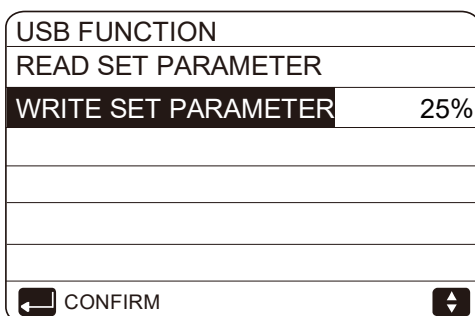

10.2 Convenient program upgrade for unit

There is no need to carry any heavy equipment but only USB disk can realize program upgrade. Steps are as follows:

Step 1:

Copy new program in U disk root directory where other files in bin format are not allowed in

Step 2:

Power on and make sure communication is normal.

Step 3:

Plug U disk into the port of hydronic PCB.

“USB” appears on digital display

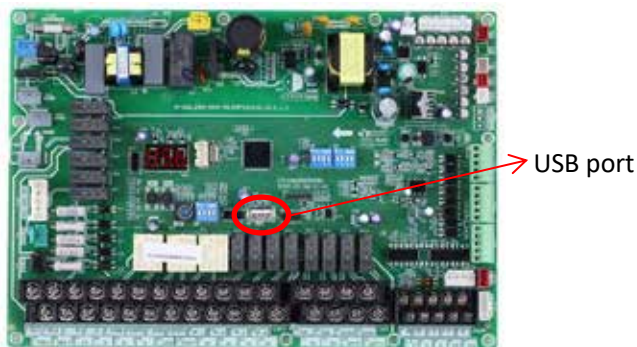

Wired controller interface automatically changes

USB FUNCTION
RATED SET PARAMETER
WRITE SET PARAMETER
PD25319B84M200415V24.bin
PD25319B86M200415V24.bin
CONFIRM

Step 4:

Please distinguish between programs for main control PCB and hydronic PCB. Select one of them and press “OK” button then rate of progress appears. When the process is finished, “SUCCESS” appears below. For upgrading outdoor unit, the process normally lasts for several minutes while only few seconds is needed for indoor unit.

Select program

USB FUNCTION
RATED SET PARAMETER
WRITE SET PARAMETER
PD25319B84M200415V24.bin 51%
PD25319B86M200415V24.bin
CONFIRM

Finished

USB FUNCTION
RATED SET PARAMETER
WRITE SET PARAMETER
PD25319B84M200415V24.bin
PD25319B86M200415V24.bin
CONFIRM

Step 5:

Pull out U disk and power on again to finish upgrading program. Check the program version to make sure upgrade is successful.

Check IDU software version

OPERATION PARAMETER	#00
Tbt1 BUFFERTANK_UP TEMP.	XX °C
Tbt2 BUFFERTANK_LOW TEMP.	XX °C
Tsolar	XX °C
IDU SOFTWARE	XX-XX-XXXXXXX
ADDRESS	5/9

Check ODU software version

OPERATION PARAMETER	#00
T3 OUTDOOR EXCHANGE TEMP.	XX °C
T4 OUTDOOR AIR TEMP	XX °C
TF MODULE TEMP.	XX °C
P1 COMP PRESSURE	XX Kpa
ODU SOFTWARE	XX-XX-XXXXXXX
HMI SOFTWARE	XX-XX-XXXXXXX
ADDRESS	9/9

11 Appendix

11.1 Environment Temperature Curves

The climate related curves can be selected in the user interface, **MENU > PRESET TEMPERATURE > WEATHER TEMP. SET.**

In cooling/mode mode, eight curves which are already set in the user interface can be selected. Once the curve is selected, the leaving water set temperature (T1s) is determined by the outdoor temperature(T4).

ECO mode is only suitable for heating mode. It has lower water temperature setting inside the program, which is more energy saving.

The relationship between outdoor ambient temperature (T4) and leaving water set temperature (T1s) is described as in Figure 3-11.2, Figure 3-11.3, Figure 3-11.4 and Figure 3-11.5.

Figure 3-11.1: WEATHER TEMP.SET menu

PRE SET TEMPERATURE		
PRESET TEMP	WEATHER TEMPSET	ECO MODE
ZONE1 C-MODE LOW TEMP	OFF	OFF
ZONE1 H-MODE LOW TEMP	OFF	OFF
ZONE2 C-MODE LOW TEMP	OFF	OFF
ZONE2 H-MODE LOW TEMP	OFF	OFF
ON/OFF		↕

The automatic setting curves are the ninth curve for cooling and heating mode, the ninth curve can be set as in Figure 3-11.6 and Figure 3-11.7.

Figure 3-11.2: Low temperature curves for heating mode¹

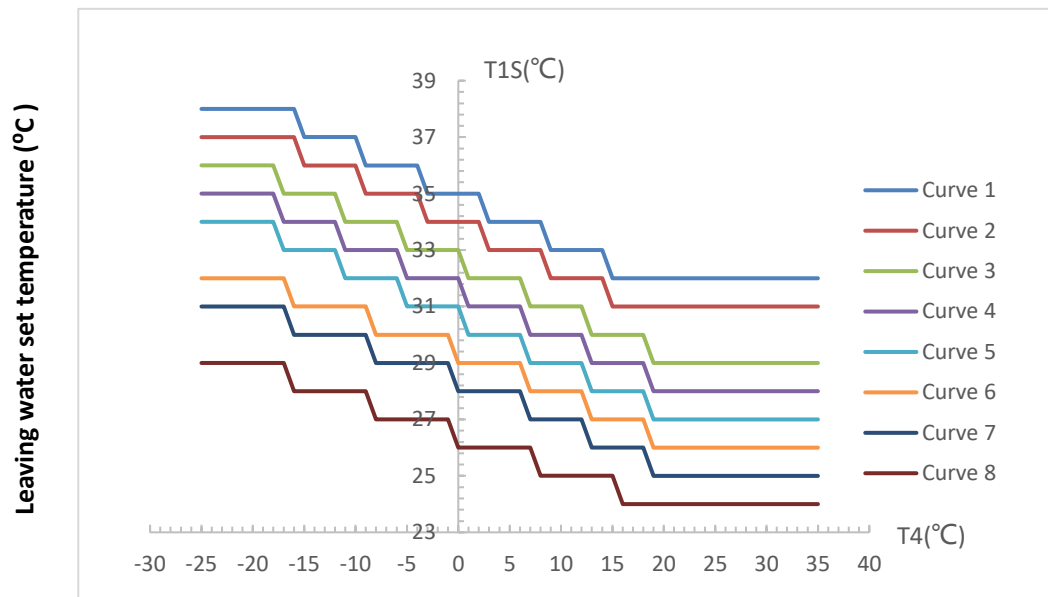

Notes:

1. It only has the curves of the low temperature setting for heating, if the low temperature is set for heating.
2. Curve 4 is default in low temperature heating mode and curve 6 is default in ECO mode.

Figure 3-11.3: High temperature curves for heating mode¹

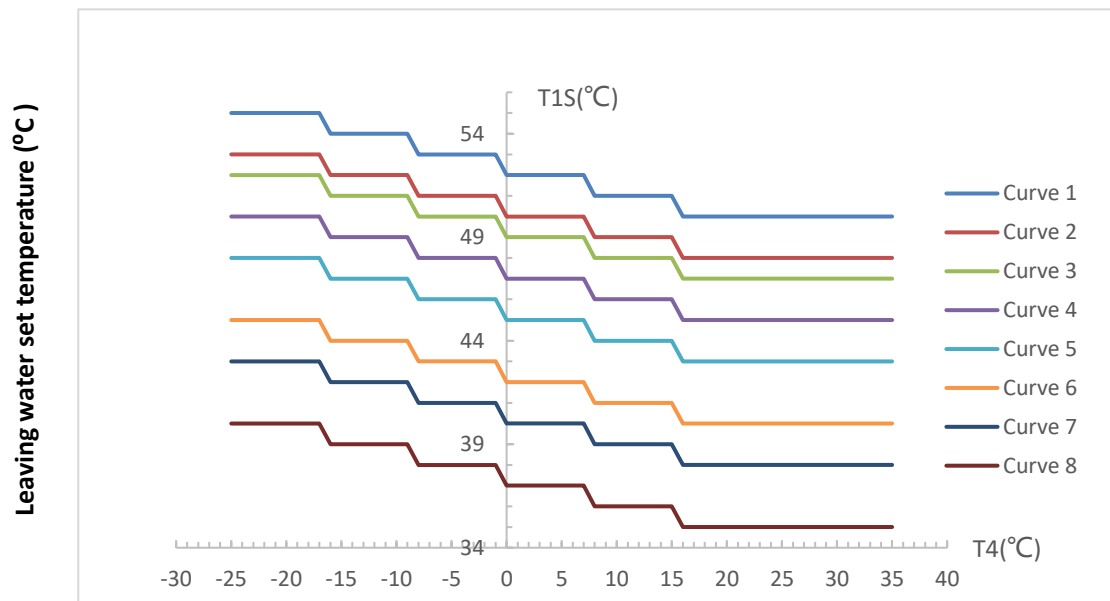

Notes:

1. It only has the curves of the high temperature setting for heating, if the high temperature is set for heating.
2. Curve 4 is default in high temperature heating mode and curve 6 is default in ECO mode.

Figure 3-11.4: Low temperature curves for cooling mode¹

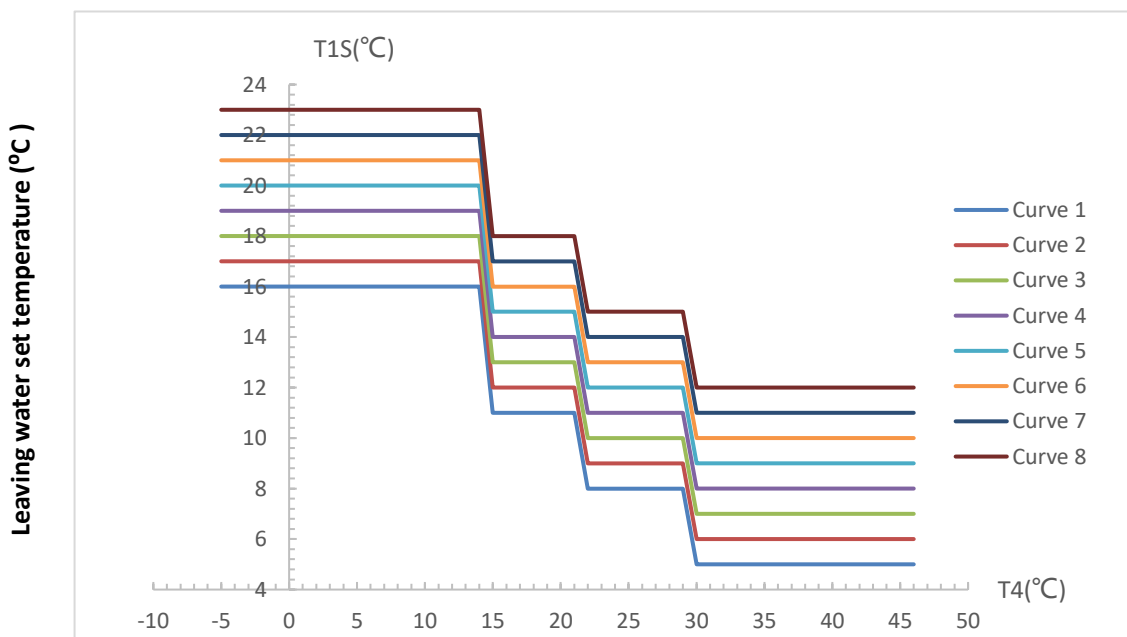

Notes:

1. It only has the curves of the low temperature setting for cooling, if the low temperature is set for cooling.
2. Curve 4 is default in low temperature cooling mode.

Figure 3-11.5: High temperature curves for cooling mode¹

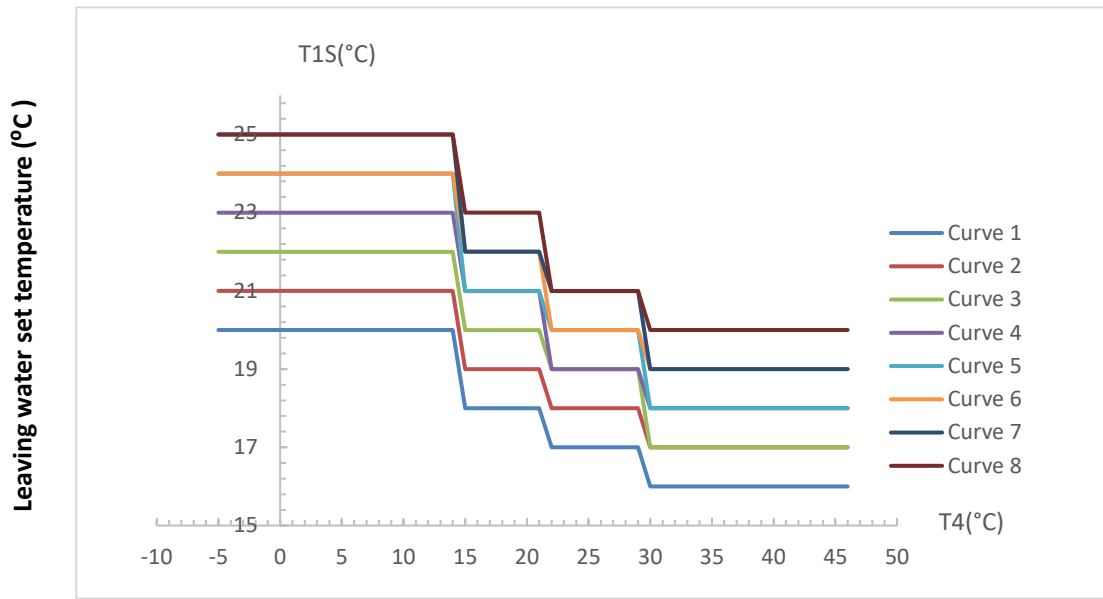

Notes:

1. It only has the curves of the high temperature setting for cooling, if the high temperature is set for cooling.
2. Curve 4 is default in high temperature cooling mode.

There is one customized curve which can set by user according to using habits. Users just need to input the ambient temperature and desire water temperature for two working condition to build the customized curve. The setting of T1SETH1, T1SETH2, T4H1, T4H2 refer to Part 3, 8.6" HEATING MODE SETTING Menu" and T1SETC1, T1SETC2, T4C1, T4C2 refer to Part 3, 8.5" COOLING MODE SETTING Menu".

Figure 3-11.6: Automatic setting curve for heating mode

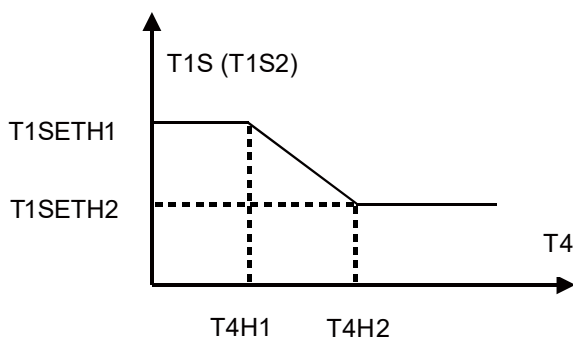
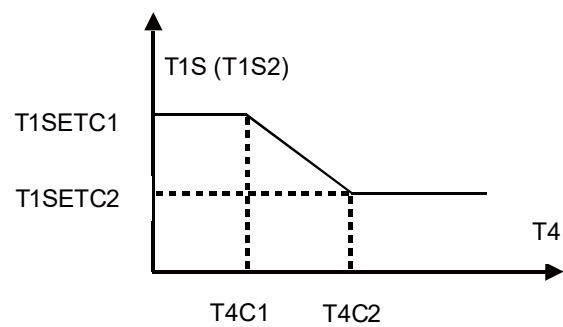

Figure 3-11.7: Automatic setting curve for cooling mode



12 Error Code Table

Table 3-12.1: Error code table

Error code	Content ²
bH	PED PCB fault
C7	High temp. protection of inverter module
E0	Water flow fault (E8 displayed 3 times)
E1	Phase loss or neutral wire and live wire are connected reversely (only for three phase unit)
E2	Communication fault between controller and main control board of hydraulic module
E3	Final outlet water temp. sensor (T1) fault.
E4	Water tank temp. sensor (T5) fault.
E5	The condenser outlet refrigerant temperature sensor (T3) fault
E6	The ambient temperature sensor (T4) fault.
E7	The balance tank up temp. sensor (Tbt1) fault.
E8	Water flow fault.
E9	Compressor suction temp. sensor (Th) fault.
EA	Compressor discharge temp. sensor (Tp) fault
Eb	Solar panel temp.sensor (Tsolar) fault.
Ec	The balance tank low temp.sensor(Tbt2) fault
Ed	The plate exchanger water inlet temp. sensor (Tw_in) fault.
EE.	The main control board of hydraulic module EEPROM fault.
F1	DC bus low voltage protection
H0	Communication fault between main control board of hydraulic module and main control board PCB B(Main control board of unit)
H1	Communication fault between inverter module PCB A(Inverter module) and main control board PCB B(Main control board of unit)
H2	The plate exchanger refrigerant outlet (liquid pipe) temp. sensor (T2) fault
H3	The plate exchanger refrigerant outlet (gas pipe) temp. sensor (T2B) fault.
H4	Three times P6 protection
H5	Room temp. sensor (Ta) fault
H6	DC fan motor fault.
H7	Main circuit voltage protection fault
H8	Pressure sensor fault.
H9	Zone 2 water flow temp. sensor (Tw2) fault.
HA	The plate heat exchanger water outlet temperature sensor (Tw_out) fault.
Hb	Three times "PP" protection and Tw_out<7 °C
Hd	Communication fault between master unit and slave unit (in parallel)
HE	Communication fault between indoor unit and Ta / room thermostat transfer PCB.
HF	Inverter module board EE PROM fault
HH	H6 displayed 10 times in 120 minutes.
HP	Low pressure protection (Pe < 0.6) occurred 3 times in 1 hour in cooling mode
P0	Low pressure protection
P1	High pressure protection
P3	Compressor overcurrent protection
P4	Compressor discharge temp. too high protection
P5	High Temperature difference protection between water inlet and water outlet of the plate heat exchanger.

Mono

P6	Inverter module protection
Pb	Anti-freeze mode protection
Pd	High temperature protection of refrigerant outlet temp. of condenser
PP	Water inlet temperature is higher than water outlet in heating mode
L0	DC compressor inverter module fault
L1	DC bus low voltage protection (from inverter module mostly when compressor running)
L2	DC bus high voltage protection from DC driver
L4	MCE fault
L5	Zero speed protection
L7	Phase sequence fault
L8	Compressor frequency variation greater than 15Hz within 1 second protection
L9	Actual compressor frequency differs from target frequency by more than 15Hz protection



**WE
CARE
ABOUT
AIR**

kaisai.com